

## Release Notes for DEPOCAM v19.0.13

18th February 2024

This new point release fixes several problems and there are several improvements too. One of the fixes relates to linking issue for waterline passes and simplified leads, so it would be wise to install this update as soon as possible. Some of the improvements affect the linking of edited area clearance and waterline passes to give fewer retracts and a smoother motion where possible. (Note: v19.0.12 was not released.)

### General:

8019: Area Clearance Passes: The default tolerance for Area Clearance, Core Roughing, and Zigzag Roughing passes has been changed. It is now one third of the XY Thickness but will not exceed 0.5mm. Before the Z Thickness was also considered, and the tolerance could exceed 0.5mm.

8066: Area Clearance Passes: Improved cases where Z slice passes were taking shortcuts (truncating corners) when the passes changed between "on surface" and "on boundary" conditions. This would in some cases result in a small amount of material being left on as the cutter moved from a surface contact to a constraining boundary limit. Also fixes tickets 9524, 6538 and 3058.

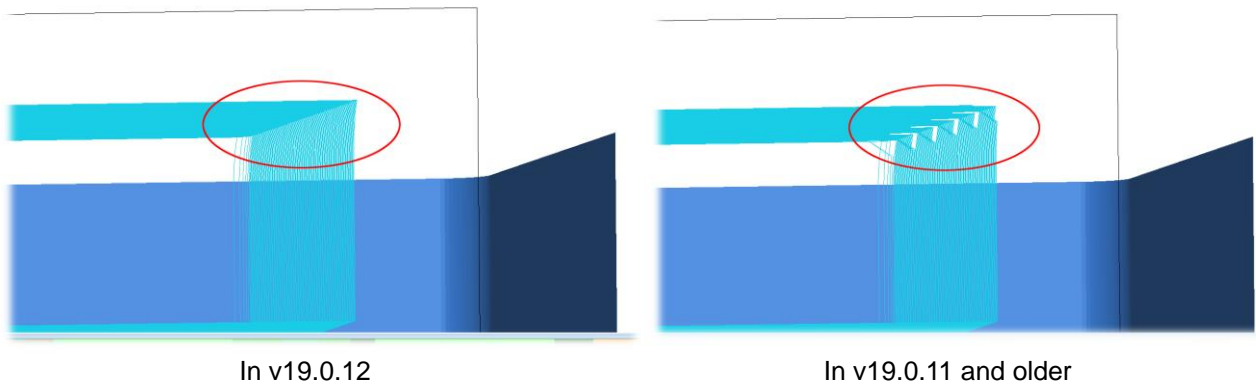

9410: Waterline Passes: Improved the results of Waterline passes, in cases where contact angle limits are used, to further reduce the possibility of passes being made outside the contact angle limits.

To try and show the issue here, passes were created in a narrow slot, the bottom of the slot was 5° from horizontal, the width (W) between the passes is small, about 10% or less of the cutters diameter. The passes should be created between 20° and 90°, the highlighted bits of pass are on a surface 5° from horizontal.

In v19.0.11 and earlier. Bits of passes can be seen in the bottom of the slot detail, which is outside the contact angle limits.

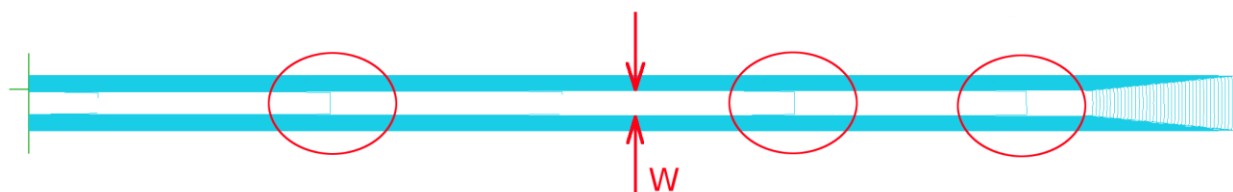

In v19.0.12 the improvement prevents the small passes being created outside of the contact angle limits.



9836: Linking: Improvements have been made to the linking motions, so we can produce non-retracting smooth (direct) connections more often and more consistently for Rest Area Clearance and Waterline style toolpaths.

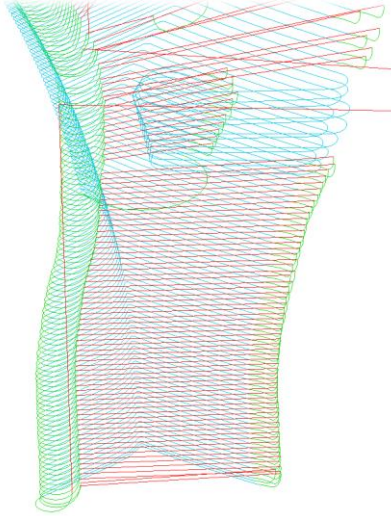
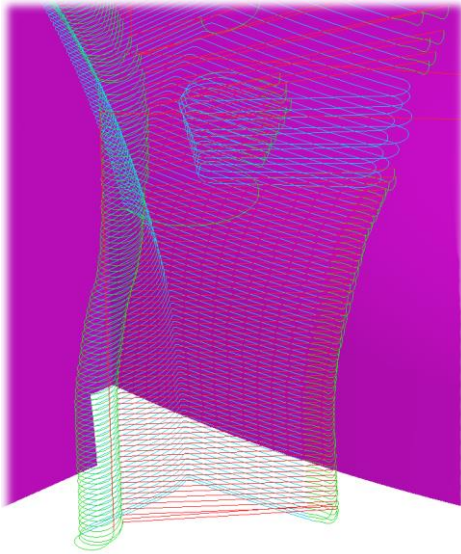

In v19.0.11 and earlier, the linking would typically arc up, the make a short rapid move before arcing down again and finally arcing back on to the next pass.

Rest roughing (with surfaces)

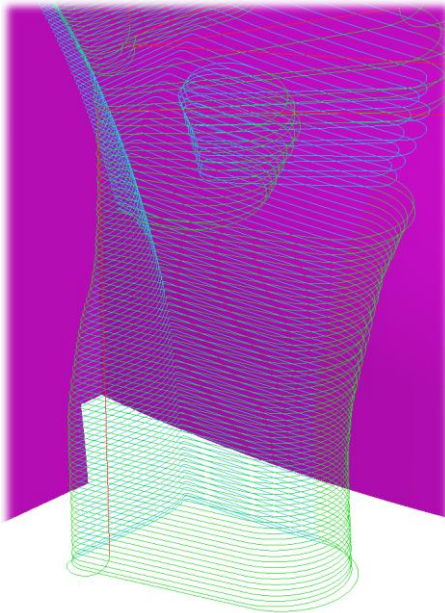

Rest roughing (without surfaces for clarity)

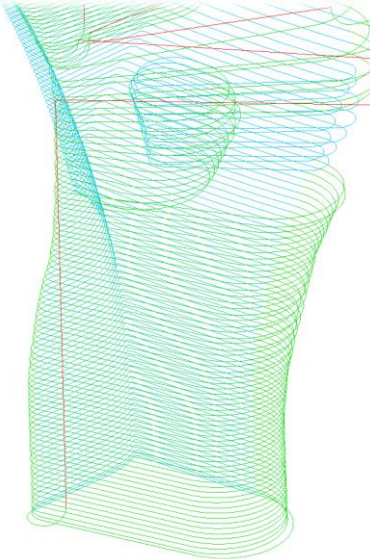

In v19.0.12 the improved linking moves between the same passes has been improved to make a smooth horizontal arc off, into a smooth ramping motion to the horizontal arc on for the next pass. This will generally give a smoother machine motion and fewer retractions.

9977: User Interface: Plans that produced warnings message in the database log window that should be checked are now highlighted in the tree view in a new colour, which is definable in the system colours.  
Database: Cancelled plans that are saved to a database now no longer start running on database load. Also fixes ticket 9219.

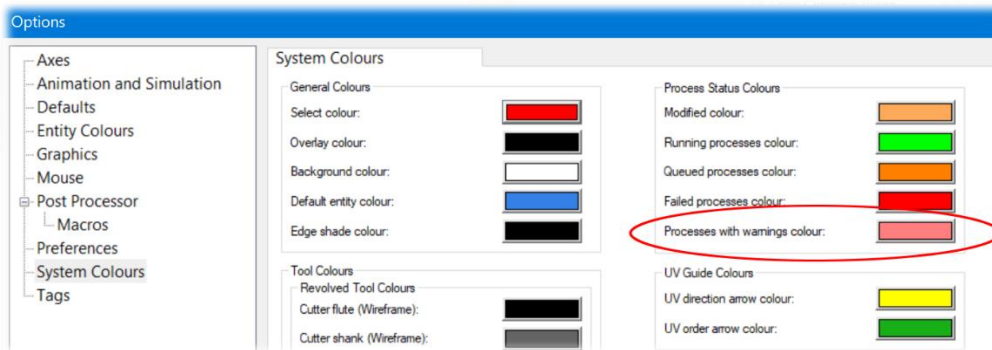
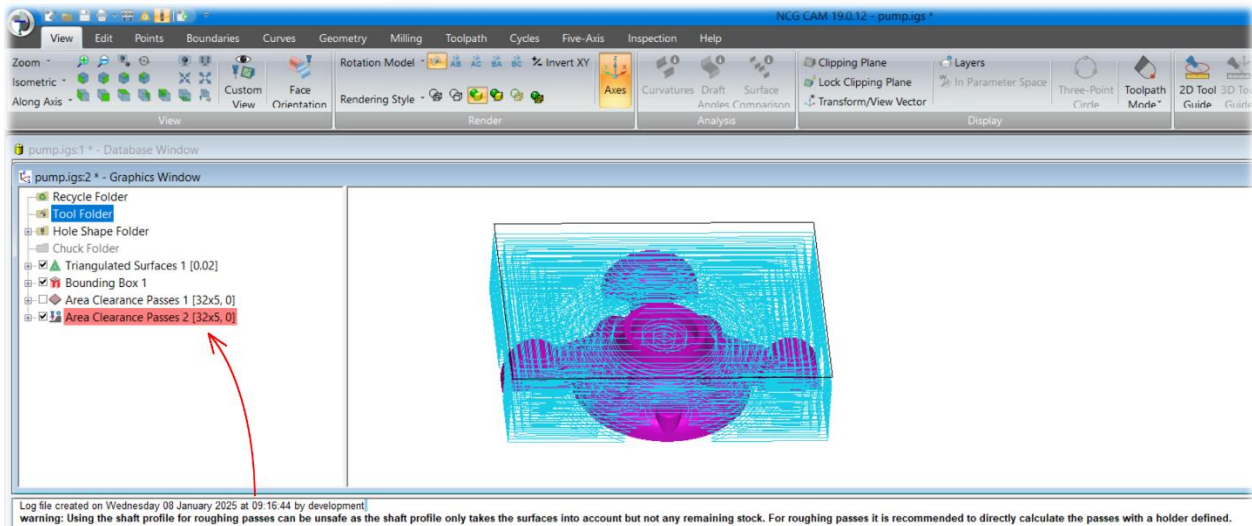

9982: Curves: Converting a canned cycle tool to a curve created no output, but the plan did not fail. This has now been fixed, and canned cycle tools can be converted to curves correctly now.

9983: Turning: There was a problem when loading a turning tool from a tool database with no holder causing a validation failure in the machining plan, this has now been fixed.

9984: Post processor: Heidenhain: Added the option, "Output Q395 = 0 for Cycle 200, 203 and 205" to suit some newer versions of the Heidenhain control that require Q395 in the cycle parameters. By default, the option is set as false, so existing post processors are not affected.

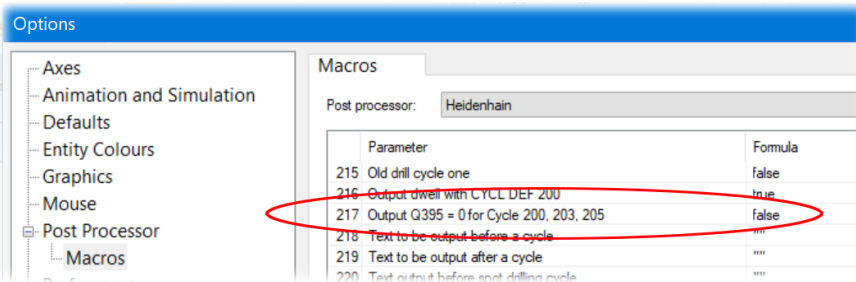

9988: User Interface: Fixed errors that could occur when attempting to move plans underneath a post-processor plan in the tree view.

9989: User Interface: Fixed a problem with plans being shown in the wrong order when moved to the bottom of the tree view.

10007: User Interface: Five axis: The dialog wording for the Five axis console, Folder Selection has been improved, from "Folder" to "Triangulated Surfaces".

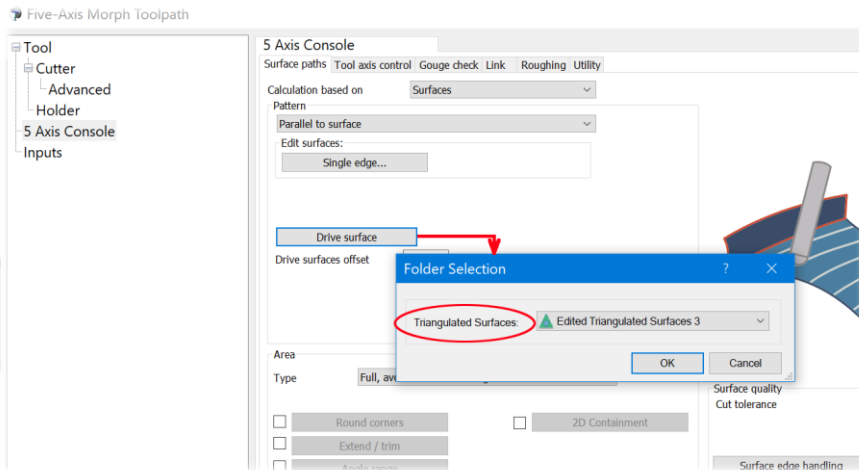

10015: Trim Surfaces: The Trim Surface to boundary option using XYZ trimmed surfaces was sometimes causing an exception and the surface(s) would not be trimmed. This has now been fixed by blocking this type of surface. If surfaces are to be trimmed to a boundary, the surface trimming needs to be UV, not XYZ.

10022: Linking: Fixed a problem which could lead to gouging lead arcs when passes have been created with very small tolerances.

10024: Linking: Rest Waterline Passes: Fixed a problem which could lead to gouges in Waterline linking when simplified leads were used, as the lead out was not applied correctly.

10028: Adaptive Clearance: The ConvexTip cutter type has been implemented for Adaptive Clearance. Select the Advanced Cutter shape to enable the required parameters. This cutter type is also available for 5 axis.

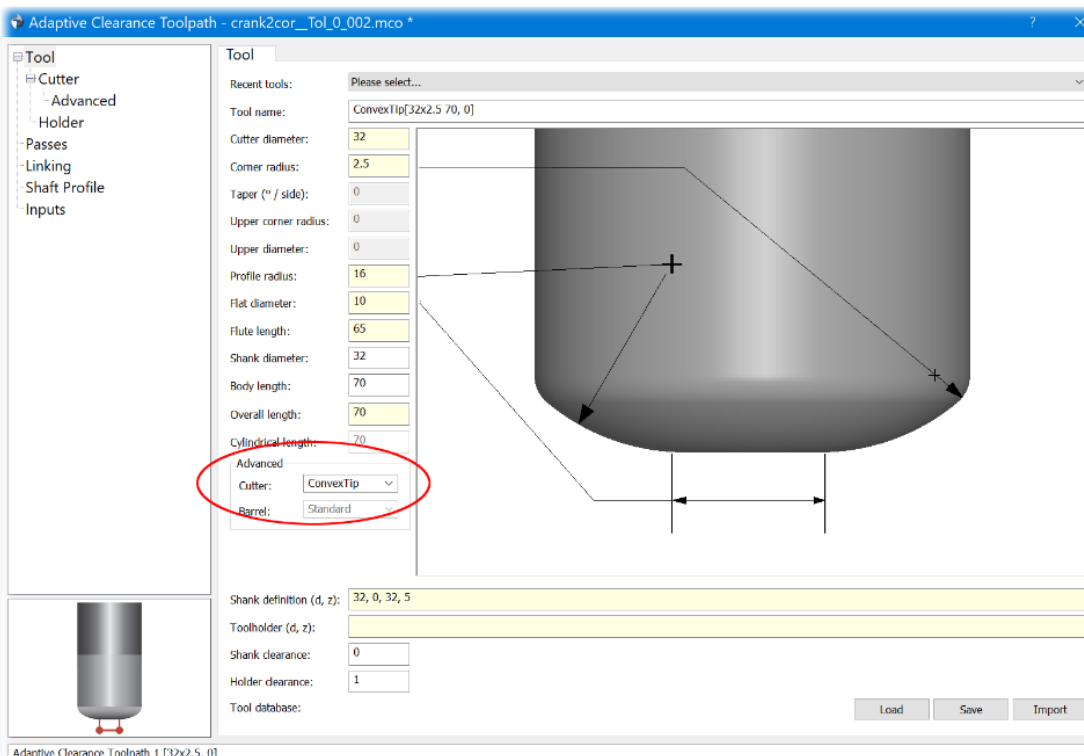

10034: Linking: Waterline Passes: Fixed a problem which meant we weren't using simplified leads for the first and last pass fragment in a stack of passes.

10037: User Interface: The wrong cycle tool diameter was being used in the recent cutter list in the tool page, if a user defined shank definition was used. There was also an issue when export cycle tools from a tool database to a text file if the user had defined the shank definition. These issues are now fixed.

10044: User Interface: There was a problem with the passes folder plan name when creating a Bore Milling cycle and the depth adjustment parameter was potentially wrong (depending on which page the shank diameter was defined), this has now been fixed.

10045: Import: Datakit libraries have been updated to 2025.1. This gives supports for SOLIDWORKS 2025. Also fixes ticket 10036

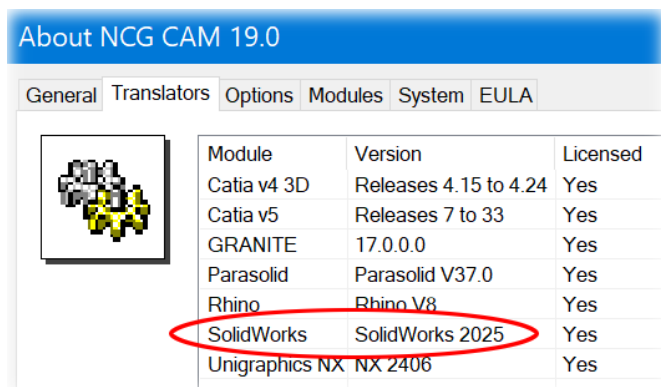

10050: Linking: Linking of Rest Roughing and Rest Core Roughing Passes were not always respecting (retracting far enough to clear) the Clamp Surfaces. This has been fixed.

10057: User Interface: There was a problem when using the Save As context menu option from the image on a tool page. If the tool name contained special characters (asterisk \*, backslash \, forward slash /, angle brackets < and >, quotation mark ", pipe |, question mark ?), the dialog would not appear, this has now been fixed by the removal of any special characters from the default file name.

10059: Linking: Improvements have been made so we can create non-retracting linking moves for edited area clearance and waterline passes in more cases. Specifically, if we cannot fit the lead arcs, we now discard the lead out arc and try and spline directly onto the lead in.

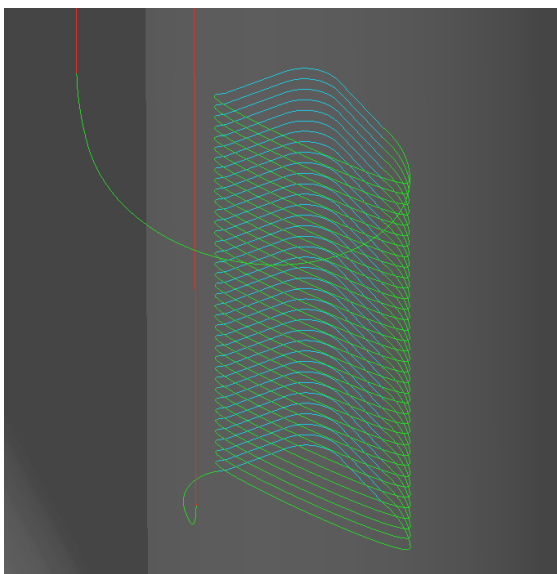

v19.0.12 – edited area clearance toolpath.

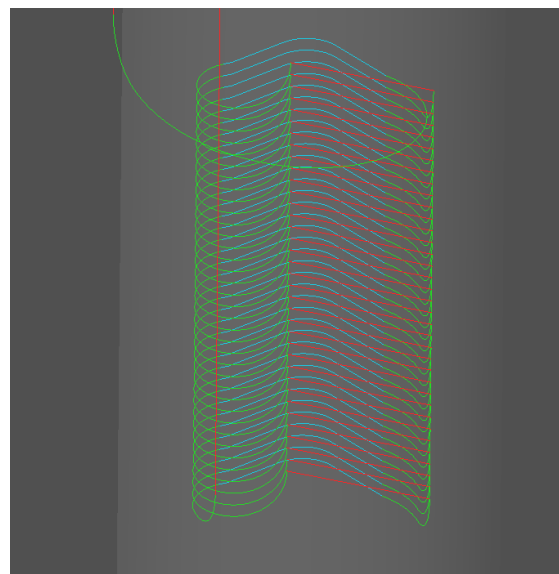

v19.0.11 – edited area clearance toolpath.

10061: User Interface: The Label Geometry option was allowing editable plans as input, this should not be permitted and has now been fixed by converting the inputs to non-editable plans.

10067: User Interface: It is now possible to save a tool with the context menu "Save As" option on a Tool, Cutter or Holder page to write the tool to an XML file in Scalable Vector Graphics format (SVG).

10071: User Interface: Fixed a user interface hang that could occur when manually starting a paused plan.

10076: Linking: Fixed a problem with the linking which could cause exceptions when running in more than one thread.

10077: Linking: Improved performance of linking plans when system memory usage is high.

10084: Linking: Waterline Passes with simplified leads and shortest route retracts. Fix an issue which meant rapid moves were not always clear of surfaces and could cause gaps in toolpaths.

10086: Linking: Fixed a problem with the linking of Rest Area Clearance Passes with Minimal Retracts which could cause the retracts to be lifted too high.

10088: Tool Database: Fixed an issue where the image was not updating correctly after deselecting an item on the Tool Database page.

10008: Macros: Macro comments were being output regardless of "Save user variables" setting, this has now been fixed. The default has now been changed to set "Save user variables" to true instead of false.

## Release Notes for DEPOCAM v19.0.11

14th November 2024

In order to keep the retracts during the rest roughing linking lower, we calculate the material still present in the process during the linking since v19.0.09. Shortly after completing v19.0.10 we discovered that, particularly when using ball nose cutters, it can happen that the cutter moves through material during the positioning that is later removed. We immediately fixed this error #9966 and created v19.0.11. Please therefore take notice of the release notes for 19.0.11 and 10.

**If you have v19.0.09 installed, you should install 19.0.11 as soon as possible.**

### Important:

9966: Linking: Fixed a problem with the modelling of dynamic stock for rest roughing linking and using minimal vertical retracts. Which could lead to rapid moves at unsafe heights through the remaining stock material, with a risk for tool breakage. Also fixes ticket 9980.

### New feature:

3484: Curves: It is now possible to extract slice curves from surfaces taking into account undercut areas of the part.

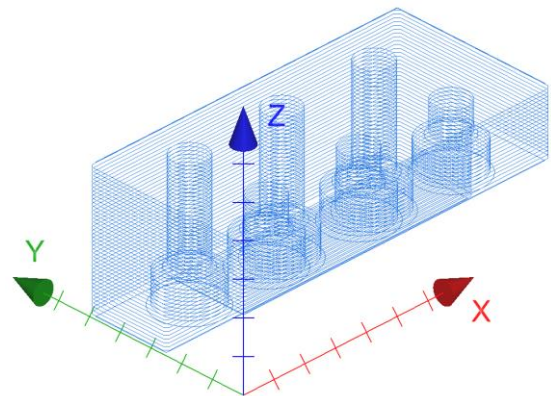
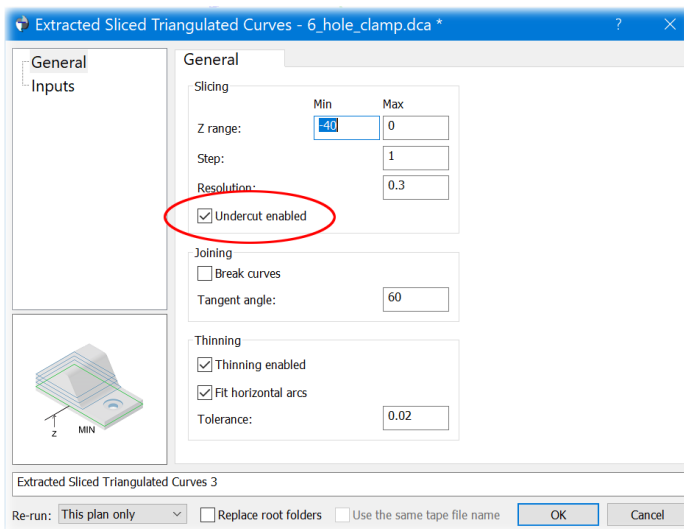

By default the **Undercut enabled** option is unticked.

### General:

9940: User Interface: Dialog guide graphics have been added to the Extract Slice Curves and Extract Curves dialogs.

9953: User Interface: The options dialog would allow you to set an invalid parameter and the OK would give a popup warning dialog but it would continue and set the parameter incorrectly. Now the dialog remains open after the error message has been confirmed and cannot be closed until the invalid value has been corrected.

9964: Waterline Stepper Passes: With Waterline Stepper Passes it could happen that the order of the linking was not correct and lower areas were linked before the upper ones. This particularly affected parts with steep walls. Now the order is correct.

9967: Five-Axis: For the transfer to the ModuleWorks libraries, sometimes surfaces have to be re-triangulated in the background. There was a problem that one surface was not trimmed correctly. This problem has now been resolved.

9968: User Interface: Dialog guides have been added to the Shallow Area Detection boundary, Theoretical Rest Areas boundaries, Rest Area boundaries and Cutter Contact Area boundaries.

9969: User Interface: The Bounding Box dialog guide graphics now uses two planes one at Z Min and another at Z Max, instead of a single plane just above the Z Max value.

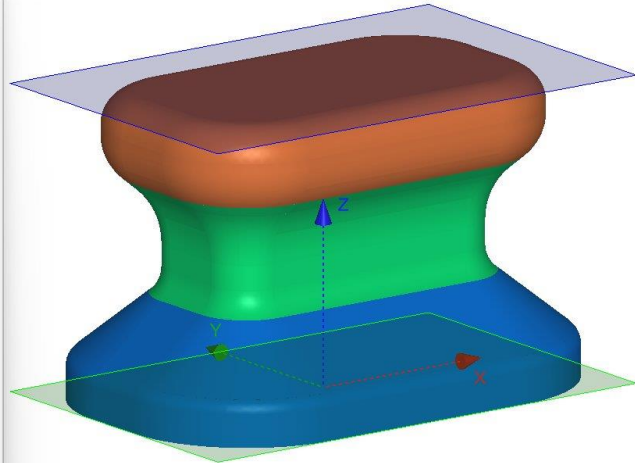
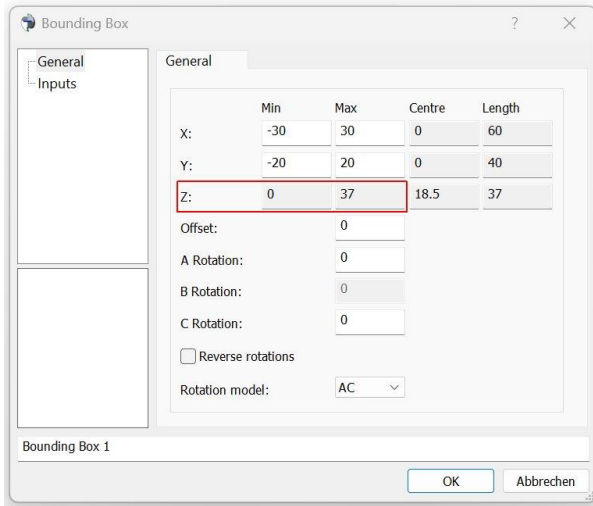

As a reminder: The dialog guides can be temporarily switched off by pressing the left mouse button in the dialog and tick or untick **Display Dialog Guides** in the context menu. If you don't want dialog guides at all, you can turn them off in **Options > Preferences** under **Menus and Dialogs**.

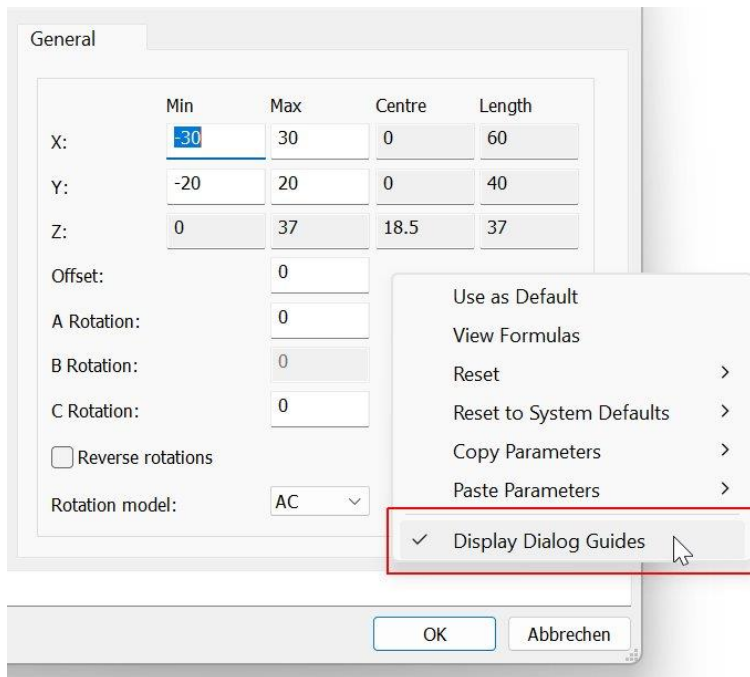



## Release Notes for DEPOCAM v19.0.10

5th November 2024

### General:

8131, 4394: Linking: Profile ramps. We now allow profile ramps onto the midpoints of open fragments (the smaller bits of line and arc that you see as the passes). This also fixes ticket 4394.

If an area is very narrow during Area Clearance roughing, so that only one path is created on the outside and inside, and the area is also too small to plunge via a helix, the cutter has previously plunged via the profile on the inside. As in the image below.

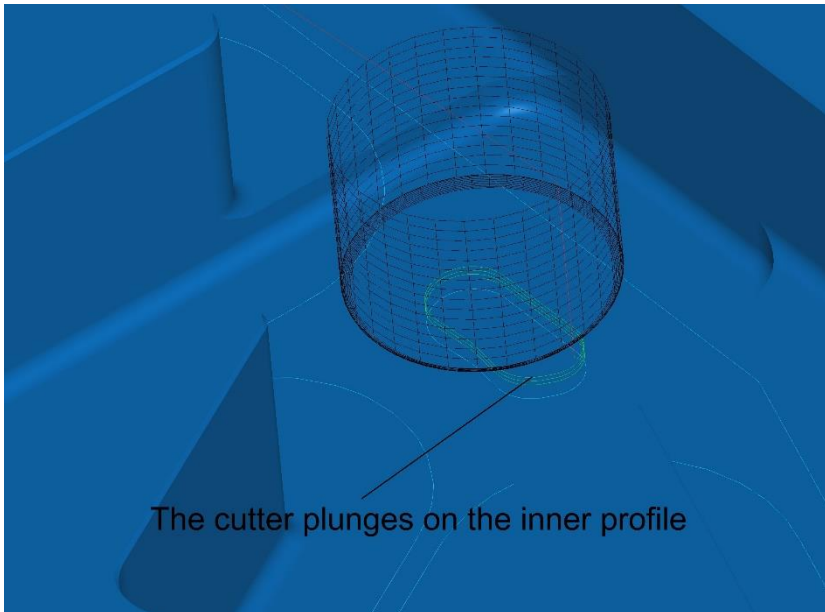

In the case of an insert cutter, this could result in the cutter getting stuck.

Now the cutter no longer plunges over the small profile, but over the outer profile and moves inwards to clear the area. As shown in the picture below.

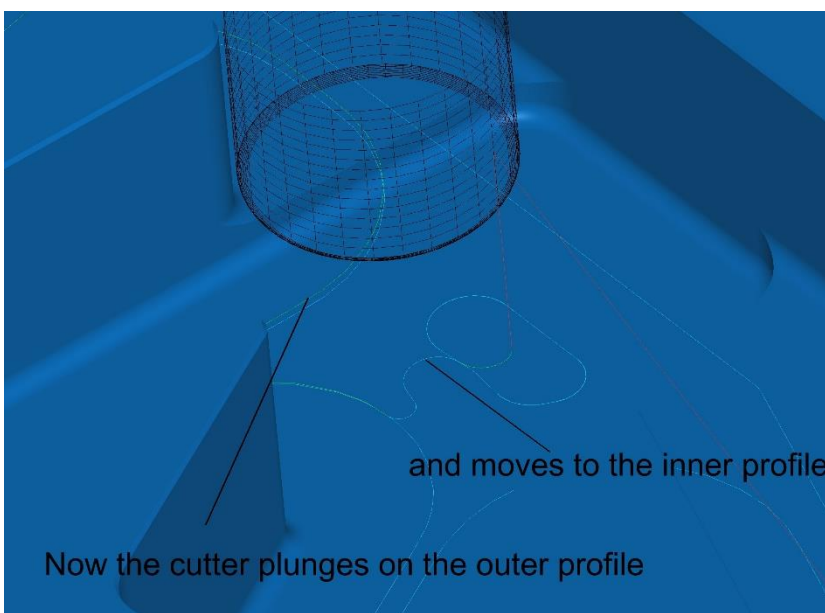

If there is enough space for the helix movement, the plunging is carried out as before with a helix.

8988: Turning Chuck: New Chuck Database has been added to Libraries

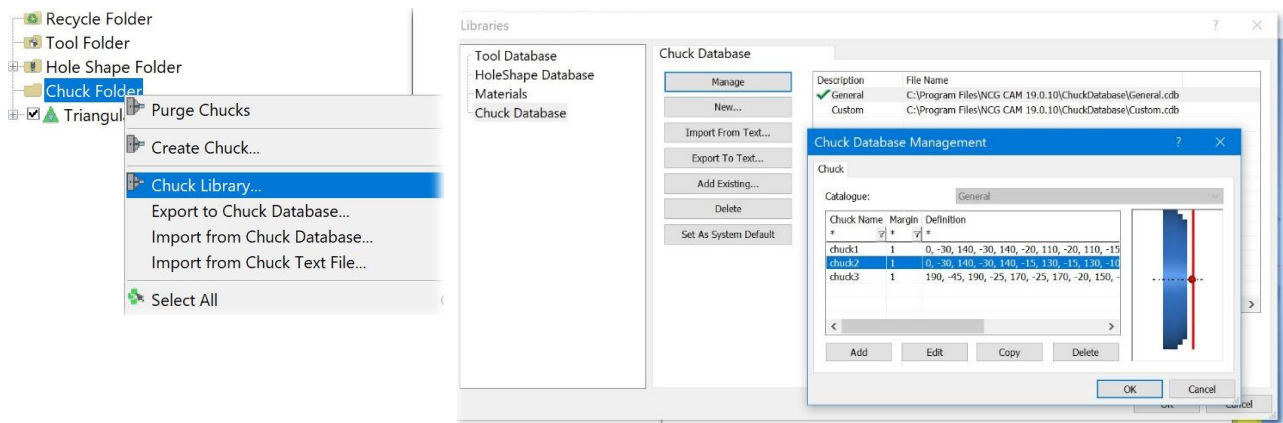

Mouse right on the Chuck folder in the contents tree. Accessing the Chuck database via the libraries.

9319: Linking Rest Finishing: Improvements have been made to the link ordering of rest finishing passes, so we take into account the height of machining passes and not just their steepness.

**Note:** For old databases, the passes will need to be rebuilt and re linked.

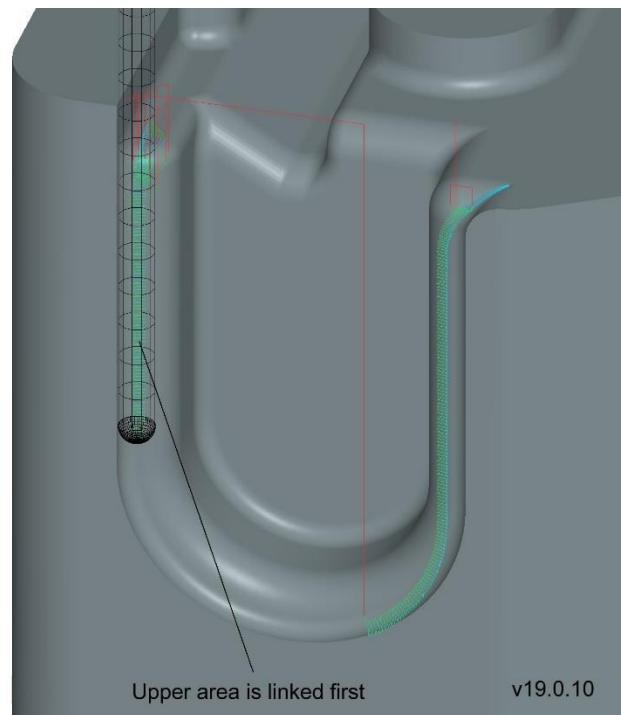
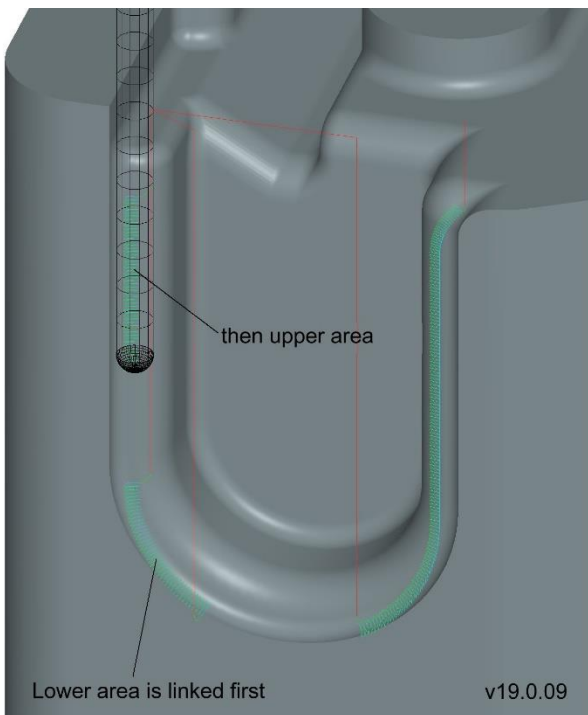

9677: ModuleWorks: The five axis libraries have been updated **MW2024-08 Service Pack 1**

9865: Five-Axis: If a 3+2 toolpath is created with the Five-Axis module using the Three-Axis output, and the toolpath is transformed afterwards, the rotation would not be output in the NC program. Also the creation of Stock Models was not possible, these issues have now been fixed.

9870: User Interface: Cutter Animation. You were unable to use the numeric keypad "." keys to set the X,Y,Z position of the cutter in the dialog, this has now been fixed.

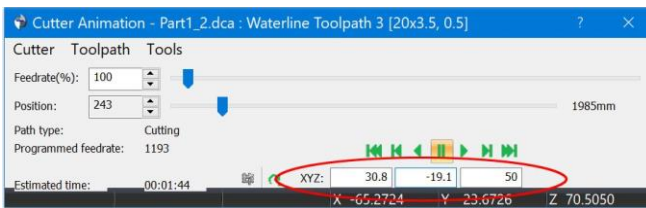

9871: Post processor: Gpost: For a left hand tapping cycle, the pitch is now output as a negative value in the APT output file.

9878: Curves: New options have been added to create a tessellated curve folder from Shaft Profile data and tool plans which create curves of the shaft profile and tool definition respectively.

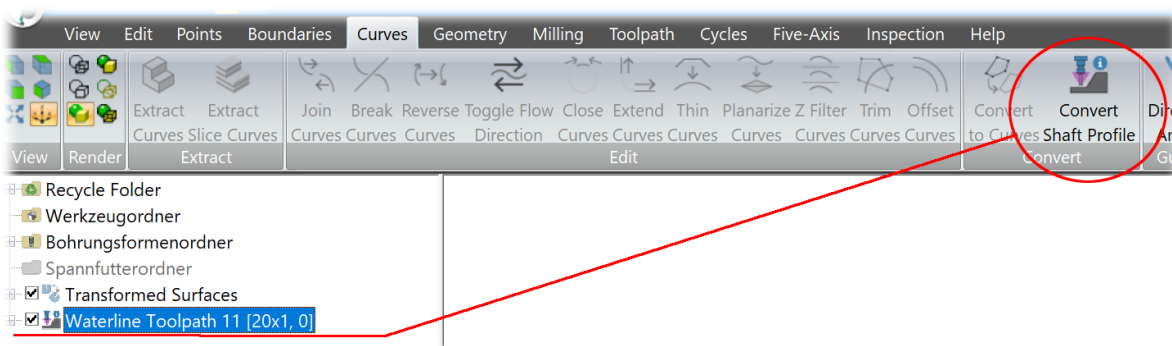

The curve can then be used directly to produce a turning toolpath, to make a custom tool holder.

9887: Adaptive Clearance: The **Safe Distance** parameter has been added to the Linking page of the dialog and the default is set to true. It ensures that during a positioning move in federate, the cutter will keep this distance from the material that will later be removed during the same machining process. This means that there is no collision with any remaining material.

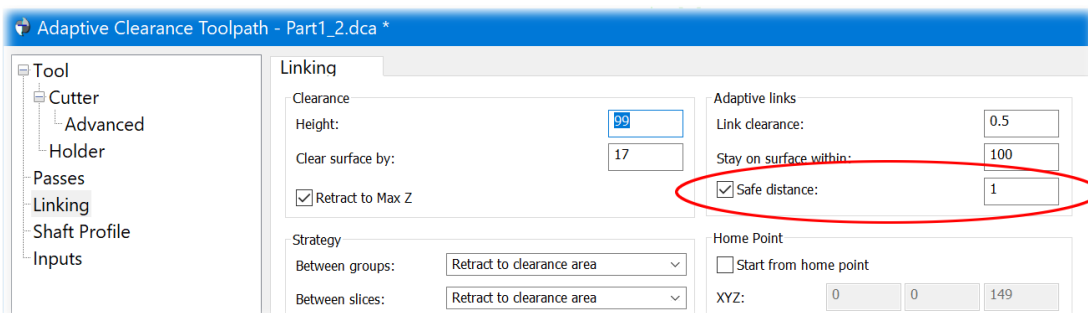

9897: Turning: There was a problem if a tool was used from the tool database it was not checked if it had been modified when doing a properties on the Passes plan, this has now been fixed.

9899: UV Machining: Fixed a problem which could lead to missing or broken passes along the edge of the surfaces, creating unnecessary retract and linking moves.

Below: Passes created before v19.0.10. the passes at the edge are broken.

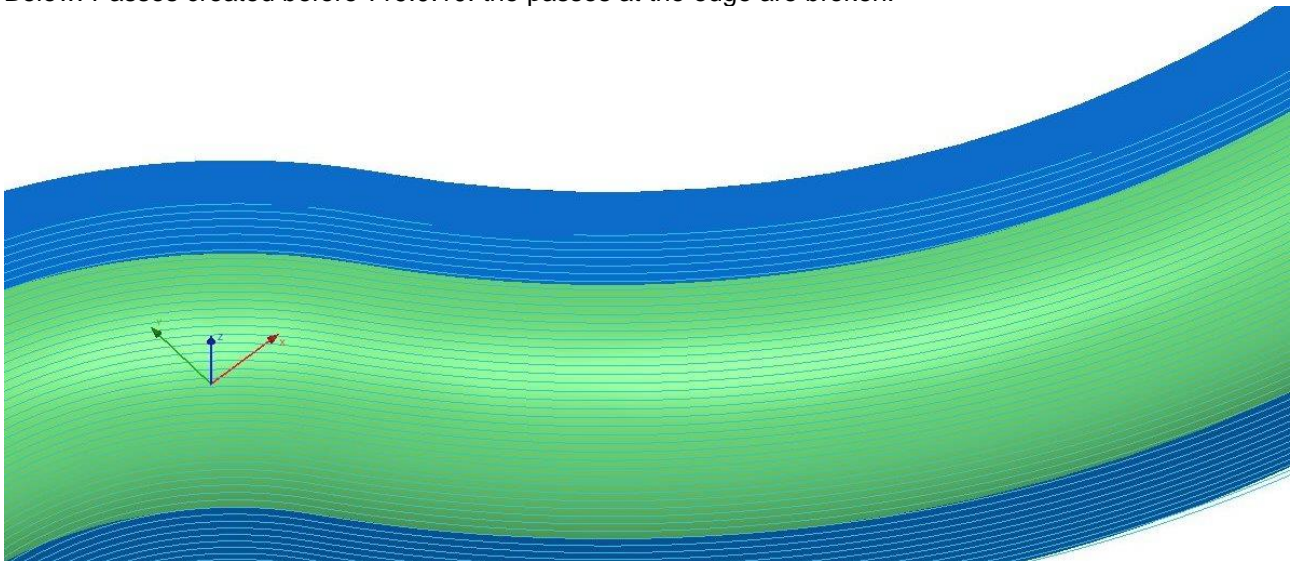

Below: Passes created with 19.0.10. The passes at the edge are closed.

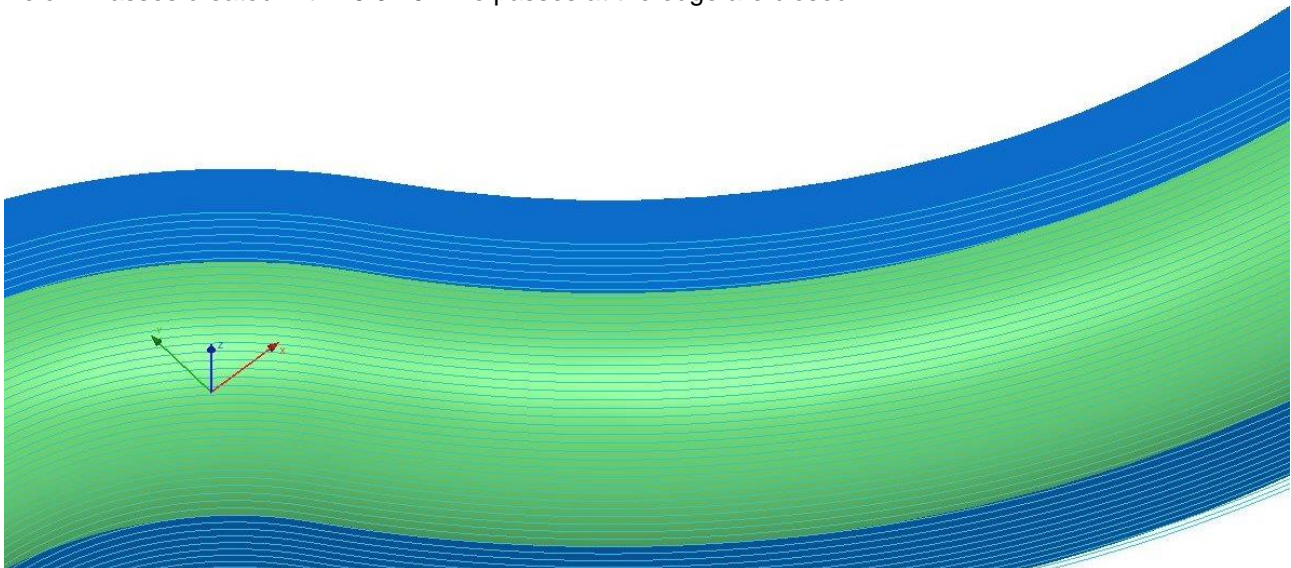

9900: User Interface: The top folder was missing if a STEP file was loaded with Load Component Information and the folder only contained one triangulated surface or curve plan.

The image below shows on the left the tree in v19.0.09, here only the surface folders were created. On the right is the directory tree in version 19.0.10 after reading in the same file. Here the main folders were created with the name of the component, and below them the surface folders. The name of the component in the main folder makes it much easier to sort the individual parts of the component.

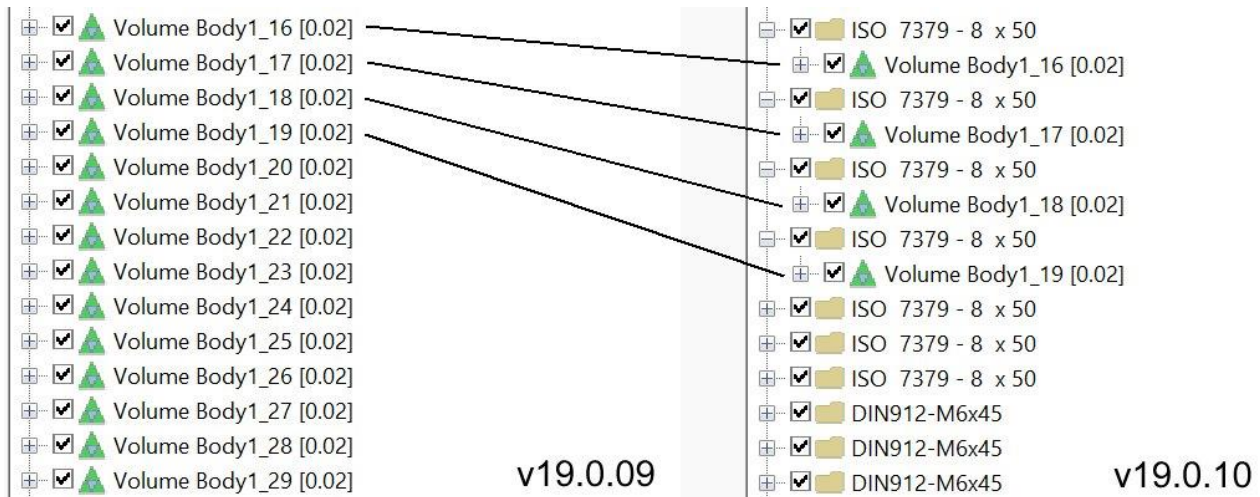

9904: Tessellation: There was an issue with building the linearized closed curve, where the triangulation occasionally failed. Surface could be broken depending on the triangulation tolerance. This problem has now been resolved. This also fixes ticket 9786

9915: Linking: Fixed a problem which could lead to missing retract moves to the Safe Z in some 3+2 toolpaths.

9924: Post processor: Siemens: Added options to output the parts limits, motions limits and the stock / tolerance details. By default they are not output so existing post processors will not be affected. Help file updated to match changes.

9928: Stock Models: There was a problem creating stock models from a toolpath with a Centre Drill, the plan would fail, this has now been fixed.

9935: User Interface: Dialog guides have been added to show the min/max Z Limits to the Edit Passes to Z-Limits dialog .

9939: Linking: Zigzag Roughing: Fixed a problem which could cause DEPOCAM to crash.

9942: Transformed Toolpaths: There were examples where a toolpath rotated around the Z axis would have the wrong rotation specified in the NC tape file, this has now been fixed.

9947: Stock Models: When creating a stock model using a rotation with negative values you were not given the option to create an open stock model when you should have, this has now been fixed.

9949: Import: The Datakit libraries have been updated to 2024.4. This supports Parasolid V37.0 and UG NX 2406. Also fixes ticket 9838

9959: Perpendicular Raster Passes: Fixed a problem which resulted in the Z limits not always respected

## Macro language:

9907: Macros: An option has been added to the Save As Macro command to "Save user variables" in a saved macro.

Dateiname: 62347\_000\_0.mco  
Dateityp: Macro Files (\*.mco)  
Display: No dialogs  
On completion: Do nothing  
 Use input geometry  
 Surface independent  
 Boundary independent  
 Drilling  
 Prompt for project settings  
 Save folder names  
 Allow empty toolpaths  
 Save user variables  
Speichern  
Abbrechen

If the option is activated, the user variables defined in project settings and the associated comments are saved in the macro and generated when the macro is executed.

## Release Notes for DEPOCAM v19.0.09

29th July 2024

This new point release covers several little improvements, the ones likely to be seen as most important are the reduced retracts when rest roughing, smoother simplified leads for waterline toolpaths, there are other improvements to other existing features too.

### General

8832 : Adaptive Clearance: It now possible to set a spindle speed decrease/increase when using ramping helix move into the job, this is done on the **Cutting Parameters** dialog, on the **Feedrate and Spindle Optimisation** page. Some cutter manufactures suggest a reduction of about 35%. A negative value is needed to reduce the spindle speed.

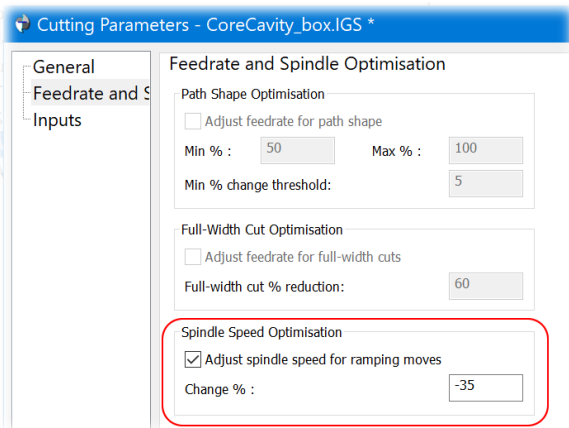

Currently this only works with the GPost, ISO, Siemens post processors for testing, other macros will follow after the testing.

**Note:** If using this feature, you should first check just how the spindle handles the speed changes smoothly before actually machining anything. Ensure there is no dwell between spindle speeds, especially if the machine switches between high and low ranges.

9660 : Linking: Simplified leads. We now discard smooth connecting moves between simplified leads if the connection would be lifted.

9688 : Linking: A new option has been added to the simplified leads dialog, **Prefer smooth connections**. This allows the user to control whether we try and create smooth, non-retracting connections between the leads, or not. The new smoothed option is enabled by default, and causes the software to behave as before.

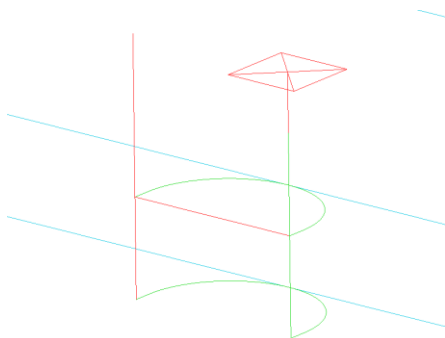

Simplified leads without smoothing  
Rapid connections

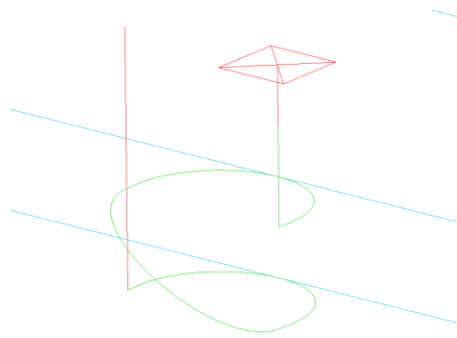

Simplified leads with smoothing  
Smooth connections

Minimise trimming  
 Fully trim pass

Trimming  
 Max trimming distance:

Simplified Leads  
 Simplified leads  
 Prefer smooth connections

Arc in angle:   
 Linear extension (in):   
 Arc out angle:   
 Linear extension (out):   
 Loop overlap:

Lead out:

Horizontal Leads  
 Lead in:   
 Max ramp angle:   
 Ramp height offset:   
 Lead out:   
 Lead out angle:

Ramp extension:

9732 : Import: Updated Granite to v17.0. This provides support for Creo 11.0 files.

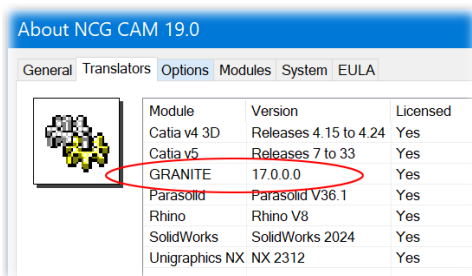

9743 : Linking: Axially Offset Horizontal Area Passes: We now consider the axial offset step when setting up the profile **Ramp height offset** distance.

9757 : Drilling: There were cases where defining a very small drill would cause an exception, this has now been fixed.

9784 : Raster Passes: Tangential and horizontal extensions were not always being applied correctly if a pass was split into multiple frags by the boundaries. This has now been fixed.

9787 : Cutter Simulation: There were examples where using the **Skip to End** option on the dialog, sometimes long toolpaths would stop short of the end and you would need to hit the button again, this has now been fixed.

9799 : Cutter Simulation: A list has been added to the dialog to show any collisions detected, this replaces the list being shown in the database window.



9799: Cutter Simulation: If **Enable Collision Checks** is activated in the Cutter Simulation, collisions between the tool and the material to be removed are now displayed in the Cutter Simulation dialog.

There are three types of collisions:

- **Rapid** – The flute moves through the material in rapid instead of at feed.
- **Shank** – The shank would remove material.
- **Holder** – The holder would remove material or collide with the material.

The dialog shows in which tool path the collision occurs and at which position.

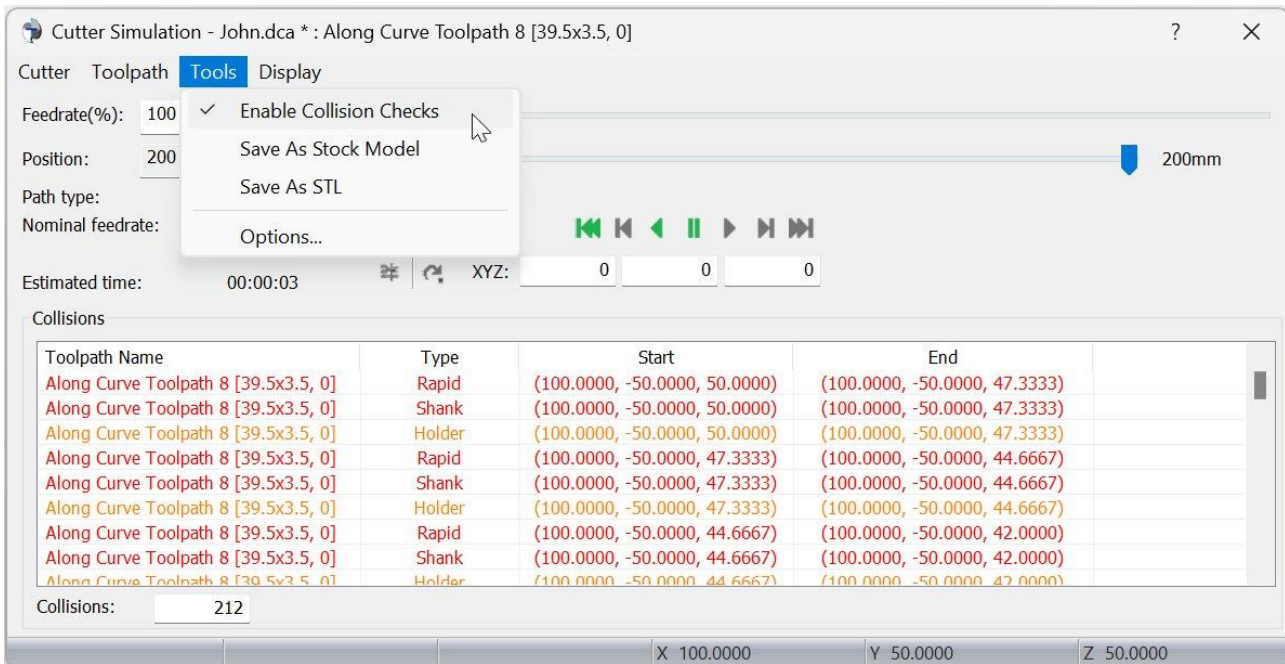

The shaft and holder are always checked. In order to detect rapid moves in which the flute moves in rapid through the material, the **Material Removal** check for the **Flute** must be activated in the Simulation **Options**, which is usually the case.

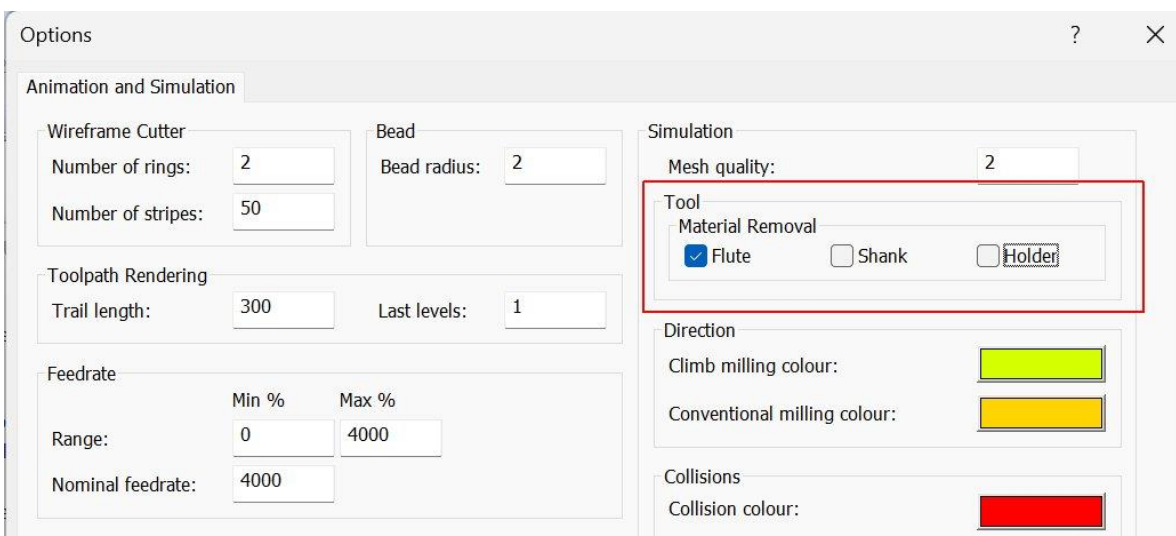

The collisions are also displayed when you jump directly to the end of the toolpath with **Skip Forward**.

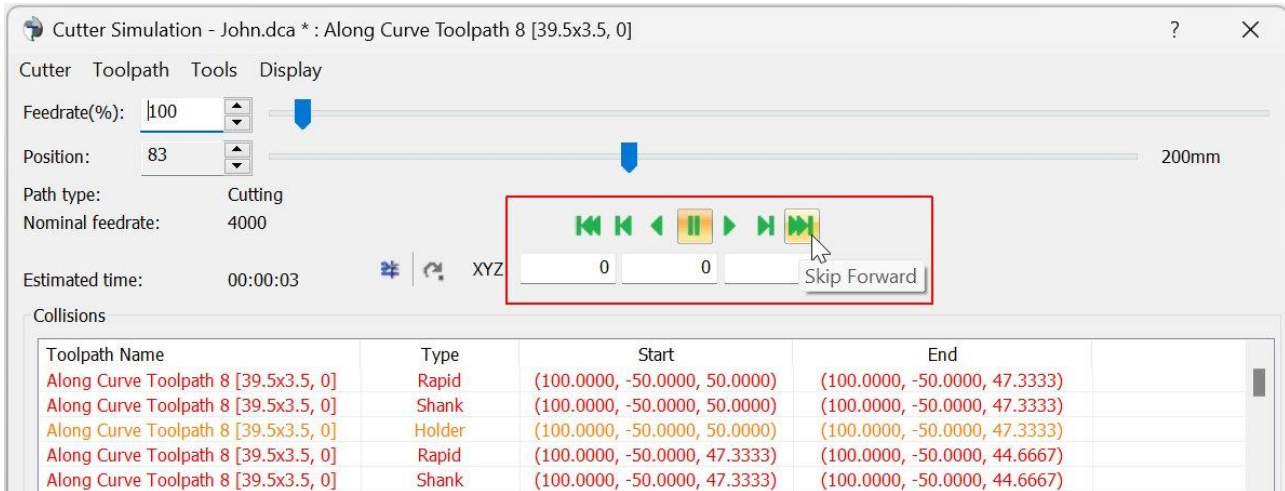

If a collision is displayed in **orange** instead of **red**, it is not yet a collision, but it shows that the holder is closer to the material than the selected **Holder clearance**. This is the holder clearance that is specified in the simulation options and not the holder clearance in the passes calculation.

9802 : Adaptive Clearance: When setting the intermediate step down greater than the step down, the dialog would not allow you to continue but gave no help on what was wrong, this has now been fixed with a suitable pop up message.

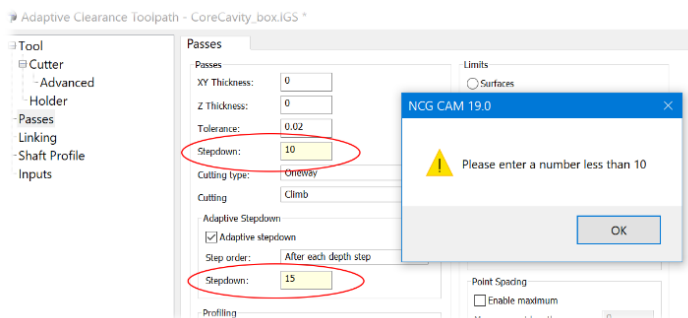

9817 : Adaptive Clearance: The permitted inputs has been made consistent with Area Clearance where you can use a stock model as the machining surfaces.

9822 : User Interface: The Rotation Model controls in the Detect Holes and Transformation dialogs were not being disabled correctly in translated languages, this has now been fixed.

9825 : Five-Axis: There were occasions when Five-Axis dialogs could crash when defining a lollipop cutter and swapping to the Passes page, this has now been fixed. End Mills were also being used to calculate cusp height these is not supported so now blocked.

9830 : Import: The Datakit libraries have been updated to 2024.3.

9833: User interface: When aligning a 3+2 machining direction to a surface, pressing the N key and clicking on the corresponding surface allows the part to be rotated so that the surface is viewed perpendicularly. This allows a boundary to be created with the corresponding rotation. There is now an additional option to align the part that does not require the part to be graphically rotated to the correct position beforehand.

If a 3+2 Bounding Box is to be created, the dialog for the Bounding Box can be opened without the Ctrl key. If the rotation model is not specified in the dialog, first select the **Rotation model (e.g. AC, BC)**. Then click with the mouse in one of the fields for the rotation values and then on the surface to be aligned with. The corresponding rotation values are entered in the dialog. A dialog guide shows the position of the machining plane.

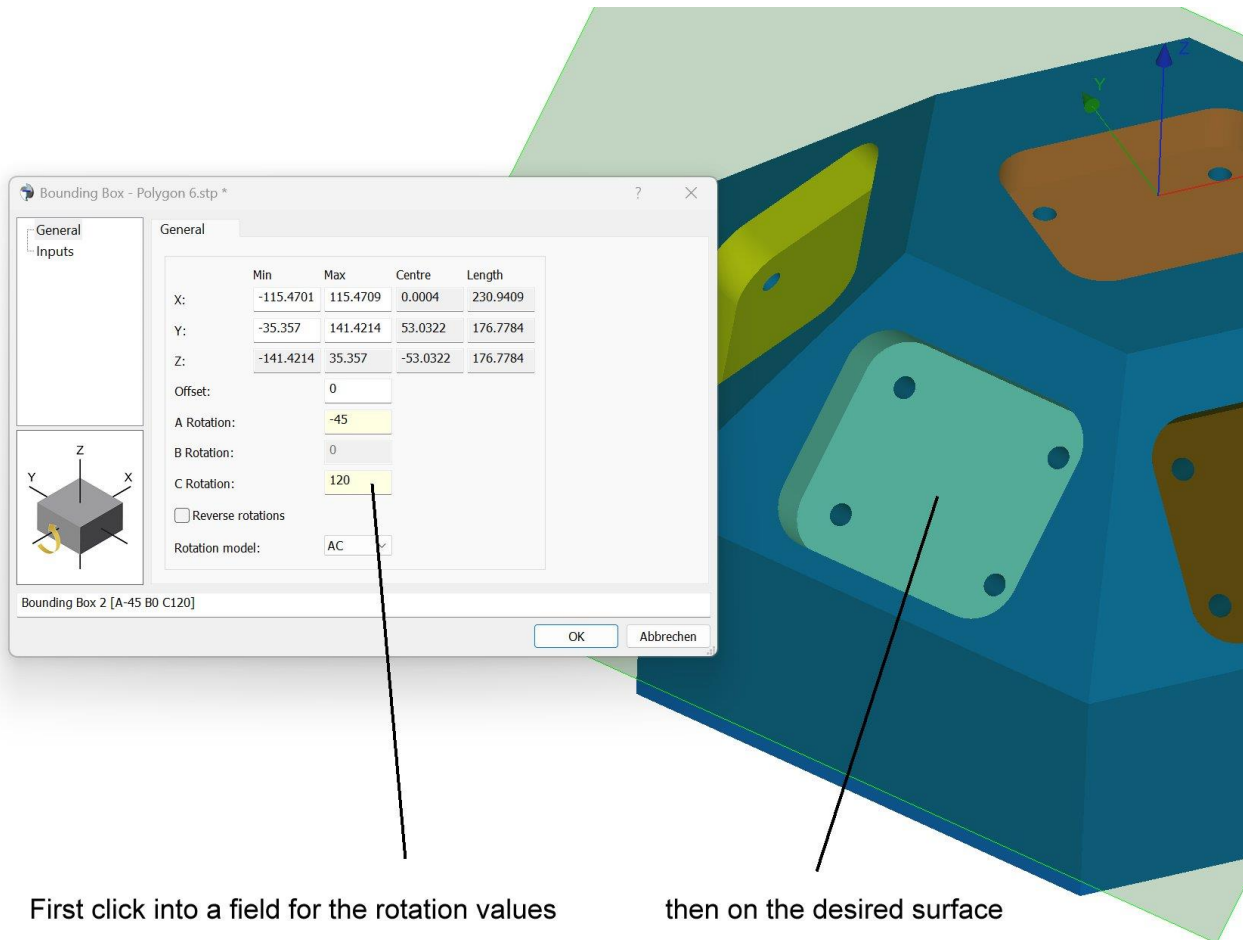

To create a 3+2 Silhouette in this way, start the dialog to create a silhouette boundary with the Ctrl key to display the advanced dialogs. In the dialog for the Bounding Box that appears, proceed as described above.

**Note :** If the Bounding Box or the Silhouette is to be created from selected surfaces, the surfaces must be selected before starting to create the boundary.

9856 : User Interface: Cutter Animation - You were unable to use the NumPad +/- keys to set the X/Y/Z position in the Cutter Animation and Cutter Simulation dialogs, this has now been fixed.

9835 and 9852 : User Interface: Some dialog guide graphics have been added to the Linking dialogs for Clearance planes, SafeZ, home and return points. A plane is displayed at the corresponding height. At a 3+2 machining, the plane lies in the machining plane. If home points are used, these are displayed as dots.

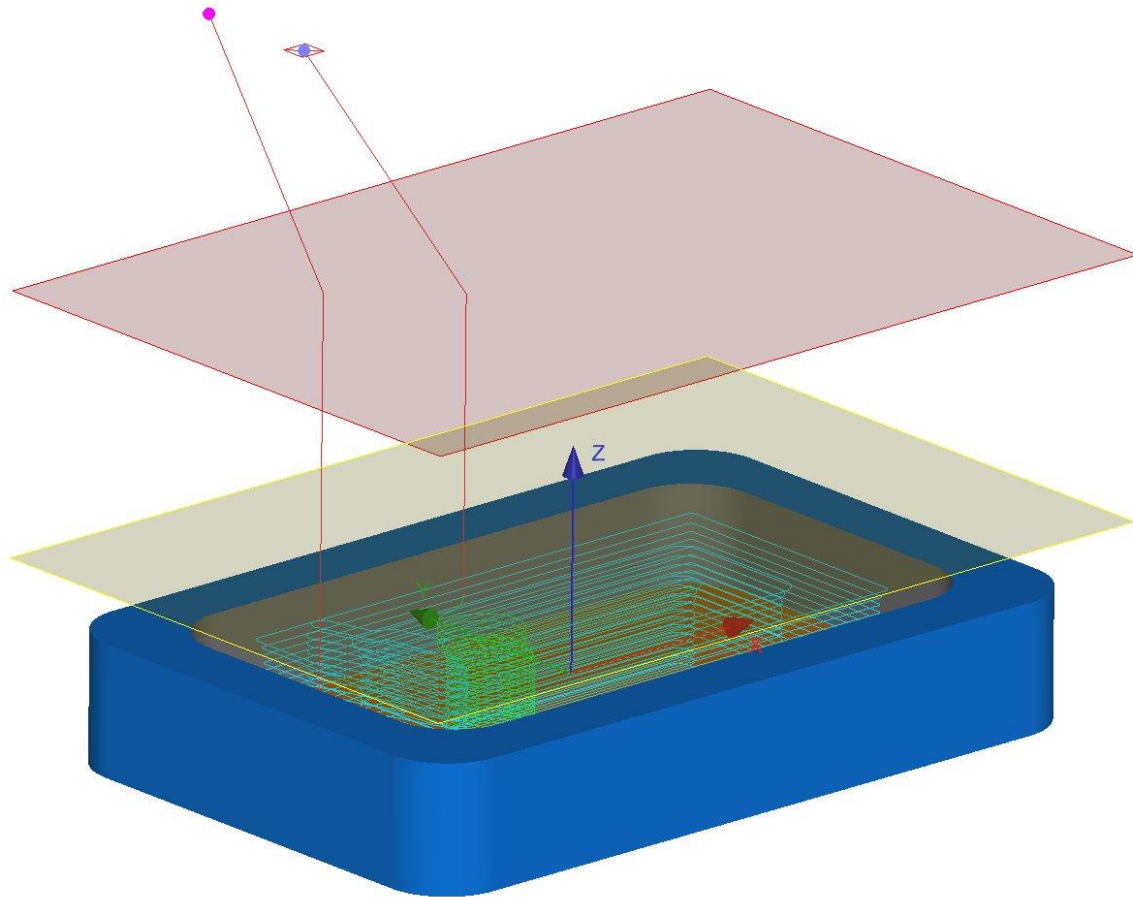

The dialog guides can be temporarily switched on or off by right-clicking the context menu in the dialog and selecting Display Dialog Guides.

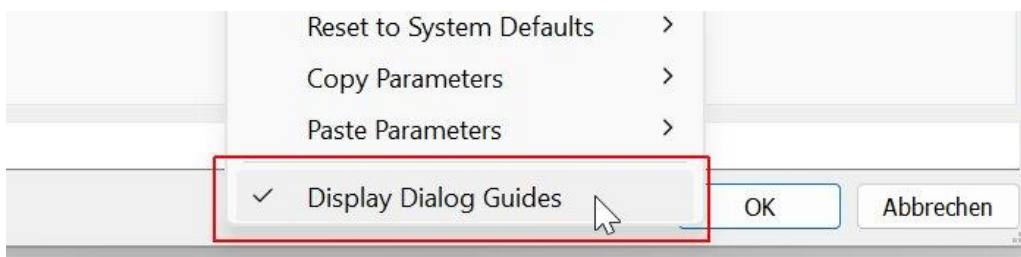

They can be permanently switched on or off under Options > Preferences > Menus and Dialogs > Display dialog guides.

9847: Linking: The linking of rest roughing passes has been significantly improved. When linking rest roughing passes, it is important to determine where there is still material during a machining operation that will later be removed in the same operation. This means that the cutter may not be allowed to pass through certain areas at the beginning of the machining operation, but may be allowed to pass through them later. Now, something like a dynamic stock model is calculated during the linking process in the background, which makes it possible to recognize where there is remaining material during the linking process. This allows fewer safety retracts to be made, as the system knows which areas have already been machined. Tests on 50 components have shown that the length of rapid moves is now 50% shorter on average.

The upper image shows the rest roughing toolpath created in version 19.0.08, while the image below shows the rest roughing toolpath created in version 19.0.09.

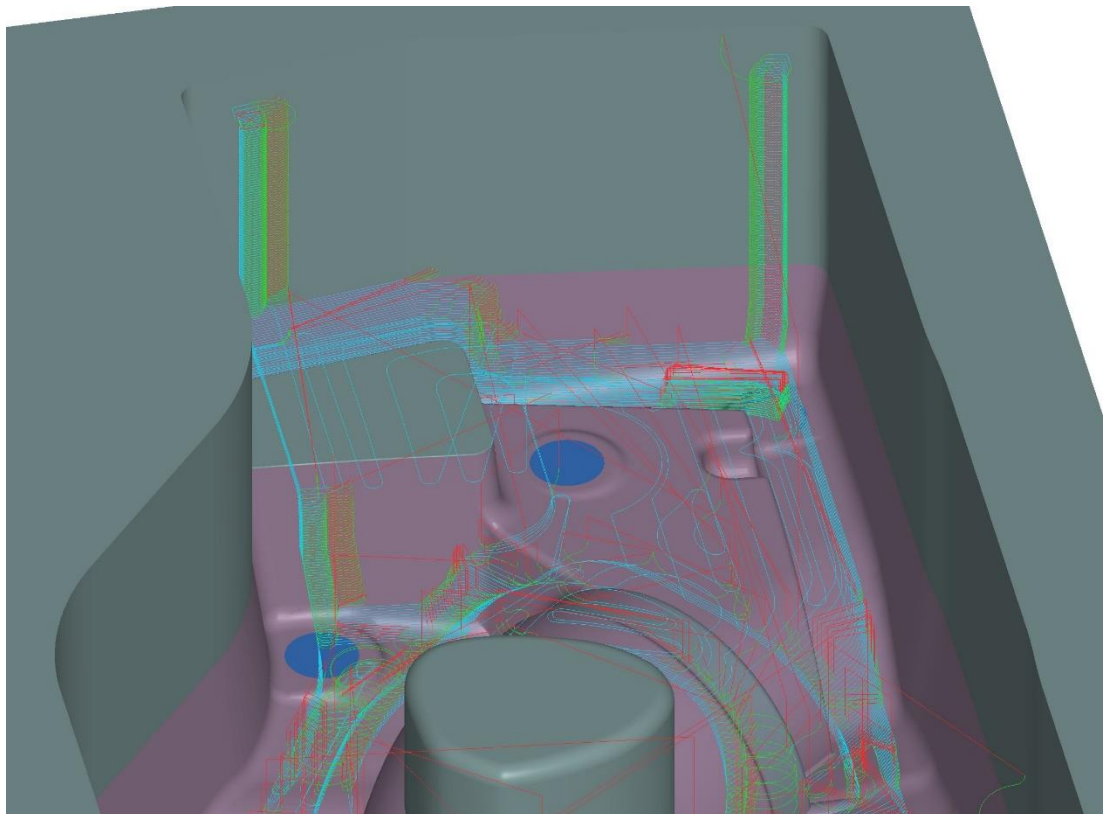
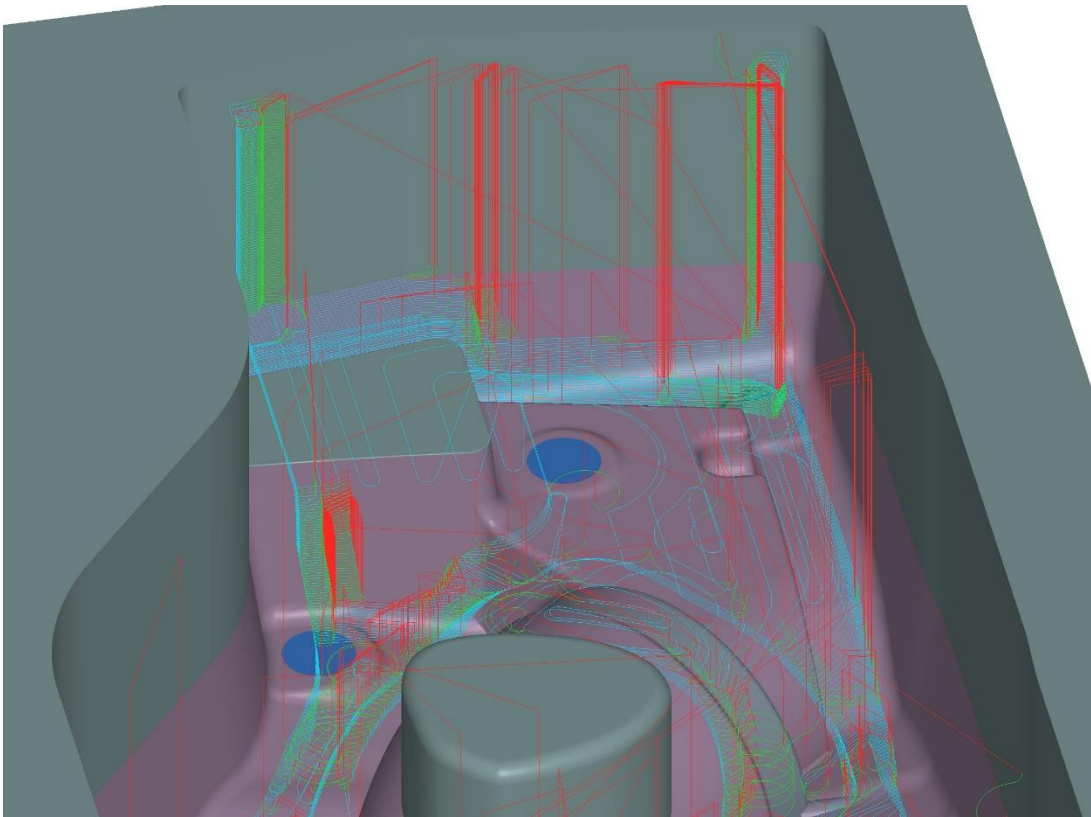

# Release Notes for DEPOCAM v19.0.08

29th May 2024

This new point release covers several little improvements, like being able to append a toolpath at the post processing stage, and fixes to existing features.

## General

5947 : Post Processing: It is now possible to add a toolpath to the list to post process on the Toolpaths page.

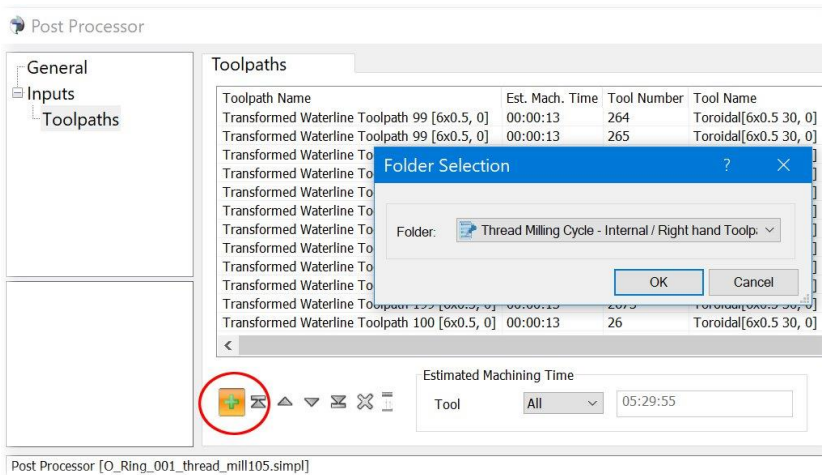

Clicking the Add button will display an additional dialog from where the toolpath may be selected. It will be appended to the current selected toolpath whenever possible. It can then also be moved up the list as required.

7709 : Stock Models: The creation of Stock Models containing thin features/walls has been improved.

8323 : Surface Trimming: The performance of trimming surfaces with boundaries improved, this also fixes a failure in trimming when using the Keep Exterior option.

9160 : Turning: Adding a front clearance angle for the turning insert (the original angle, is also renamed as Rear clearance). In addition it is possible to define a lead angle less than 90 degrees for the position of the insert

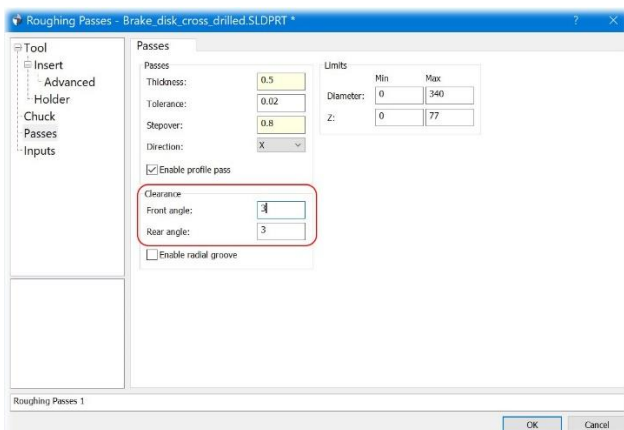

9508 : User Interface: A new option has been added to the Options > Preferences page to set the default "Display Dialog Guides" option (the graphical planes displayed for the Z-min / Z-max when creating passes).

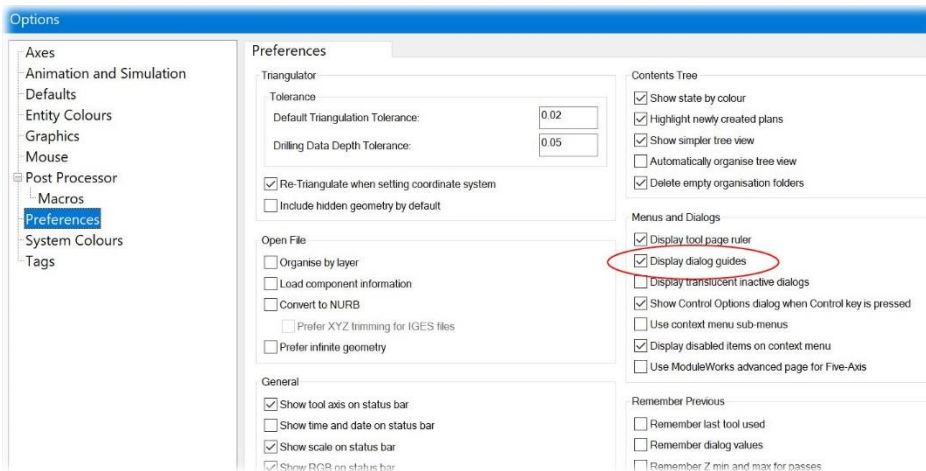

9542 : Five-Axis: Improvements to Linking Dialog page to include more options for the selected strategy.

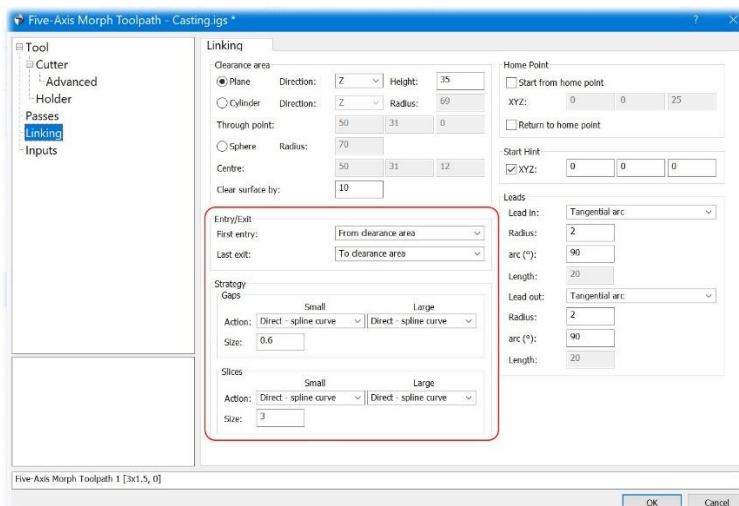

9635 : Revolved Stock Model: In turning mode, it is now possible to create a revolved stock model from a closed curve.

9662 : Drilling Linking: The clearance height for drilling toolpaths is now derived from the setup clearance from the cycles plan's + 2mm as the default.

9670 : User Interface: Add Shift and Control options to Label Geometry with Curves to give "Top Triangulated Curves" and "Bottom Triangulated Curves" respectively.



9676 : Linking: Fixed a problem which could lead to discontinuities in Waterline Constant stepover toolpaths.

9679 : Turning: The calculated machining time for Facing and Parting Off plans has been improved.

9681 : Cutter Animation: The programmed Feedrate was not displayed correctly for Turning Cutting Parameter plans, this has now been fixed.

9695 : Drilling: There were occasions when reading an old dca file with a drilling plan could cause DEPOCAM to crash due to a recursive parameter definition, this has now been fixed.

9696 : Stock Models: There were occasions where a Multi-Axis stock model would cause a crash if the tool axis swapped directions between two consecutive moves this has now been fixed.

9698 : Turning 2D Stock Model: There were examples when this could crash DEPOCAM if empty output profiles were created, this has now been fixed.

9699 : Turning Stock Models: Selecting a zero or very small Z range for the stock model would cause DEPOCAM to crash, this has now been fixed.

9700 : UV Machining: Fixed exception that could be thrown when calculating UV passes.

9702 : Tool Database: A column for the tool comment has been added to the tool database tools list page.

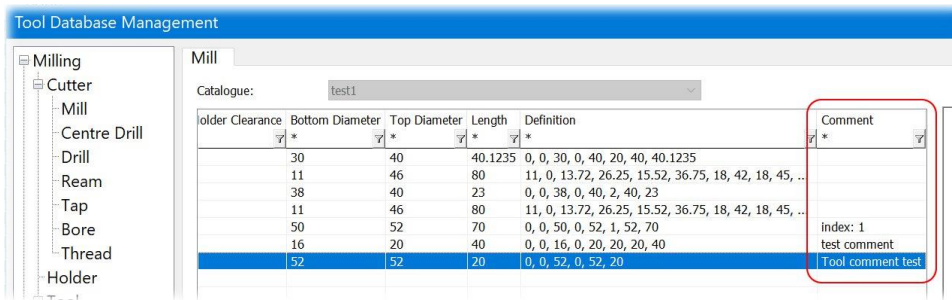

9712 : Linking: Fixed a problem which could cause gouges in axially offset core horizontal area toolpaths.

9713 : User Interface: The UV Passes button on the Milling ribbon was not greyed out if a single Stock Model is selected which is not correct, this has now been fixed.

9714 : Stock Models: Turning stock models now have the option to select tool parts which remove material, this is now consistent with the milling stock models.

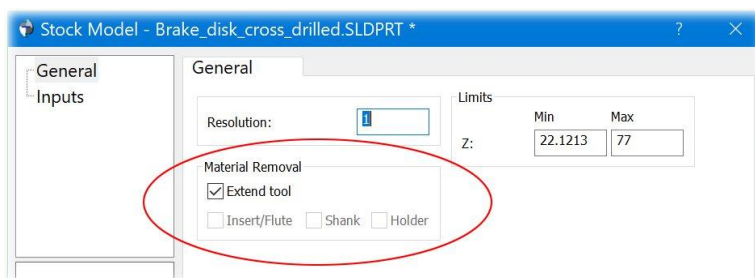

9719 : Linking: Axially offset horizontal area and axially offset core horizontal area toolpaths. Fixed a problem which meant rapid moves might not respect remaining stock.

9723 : Adaptive Clearance: The validation of the intermediate step down has been fixed to ensure that it is greater than or equal to cut tolerance and less than primary slices depth step.

9724 : Linking: The retract clearances above machined slices are too low. This has been modified so we try and respect the clear slice by distances in all cases.

9727 : Cutter Simulation: A new message has been added to the Collision checking option, to output a message to the database window. if a rapid move has a collision between the flute and the stock.



9728 : Cutter Simulation: New options to set Gouge-Excess thresholds when gouge checking with cutter simulation have been added to the Options dialog.

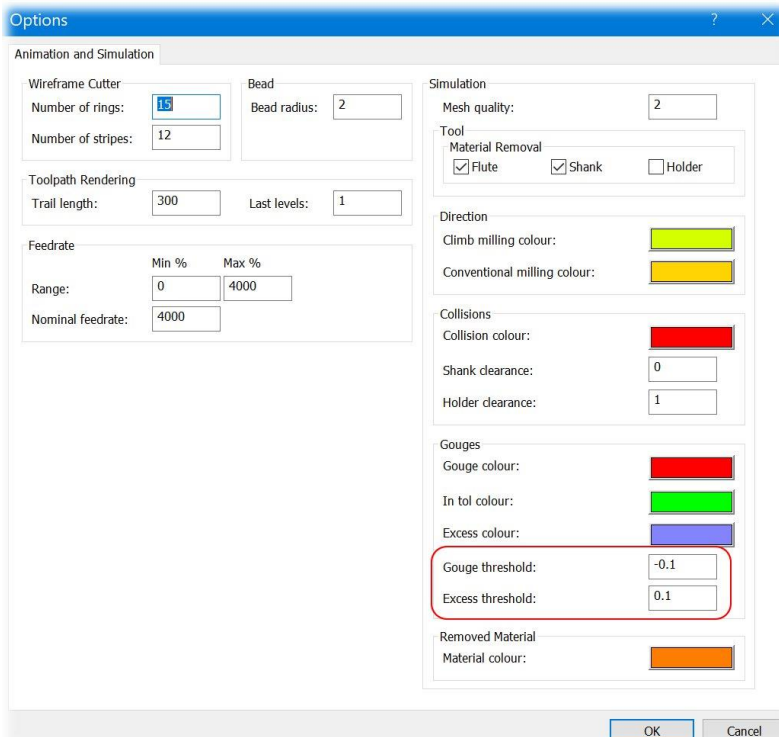

9730 : Post Processor: DATRON next: Added a post for the DATRON next controller. Help file updated.

9731 : Import: Datakit libraries have been updated to 2024.2. Supports Parasolid V36.1 and UG NX 2312. Also fixes tickets 9548 and 9596.

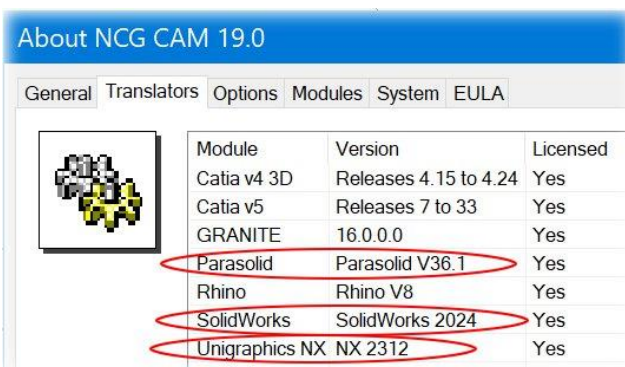

9734 : Convert to Boundaries: Was throwing exception when converting extracted slice curves. This has now been fixed.

9737 : User Interface: It is no longer possible to select the wrong type of plan as input to an editing (meta) plan through the inputs page. Where this happens in macros the plan now fails with an error message.

9738 : Linking: Linking remaining core roughing passes could in some instances generate an exception, this has now been fixed.

9741 : Linking: We were adding an additional thickness of 0.1mm to the 'Clear by' distance internally. This has now been removed.

9744 : The program could exit when performing multiple selected surface waterline operations at once. This has been fixed.

9745 : Fixed strings in autosave macros and macros written via "Save As" not being escaped correctly

9747 : Toolsheets: There was a problem where the total machining time for each tool was not always correct, this has now been fixed.

9749 : User Interface: The ribbon and tree view icons have been improved for Cycle Linking plans.



9751 : ZigZag Roughing: Fixed exception in Zig-Zag roughing passes.

9753 : Morph Passes: The program would sometimes crash when morph passes were generated within a corrupted boundary. This has now been fixed.

9755 : Linking: Fixed an exception in waterline linking with simplified leads option selected.

9756 : Turning: There was a problem generating turning profile passes, sometimes a pass was missing, this has now been fixed.

9758 : Detect Holes: an exception was thrown when there are no boundaries. This has been fixed.

9759 : Edited Toolpath: an exception was thrown when there are no boundaries. This has been fixed.

## Release Notes for DEPOCAM v19.0.07

13th March 2024

This point release covers several little improvements, along with several fixes to existing features. There was a problem with retract moves in v19.0.06, this is why we released v19.0.07 earlier, therefore please have a look at the release notes of both versions.

In v19.0.07 is a change (new parameter) in the linking of roughing passes regarding retracts, it is well worth reading the detailed notes on page 2, ticket 9595.

### General

9470: Surface Trimming: The trimming of vertical surfaces lying wholly within the trimming boundary will no longer be recreated as this is not necessary.

9499: Surface Trimming: Surfaces from a raw file cannot be trimmed with a boundary - the plan will fail. Now the message "Trimming raw surfaces with a boundary is not supported" will be displayed in the database window.

9547: ModuleWorks: Previously the Point Distribution dialog on the advanced page would crash when used for Five-Axis machining, this has now been fixed.

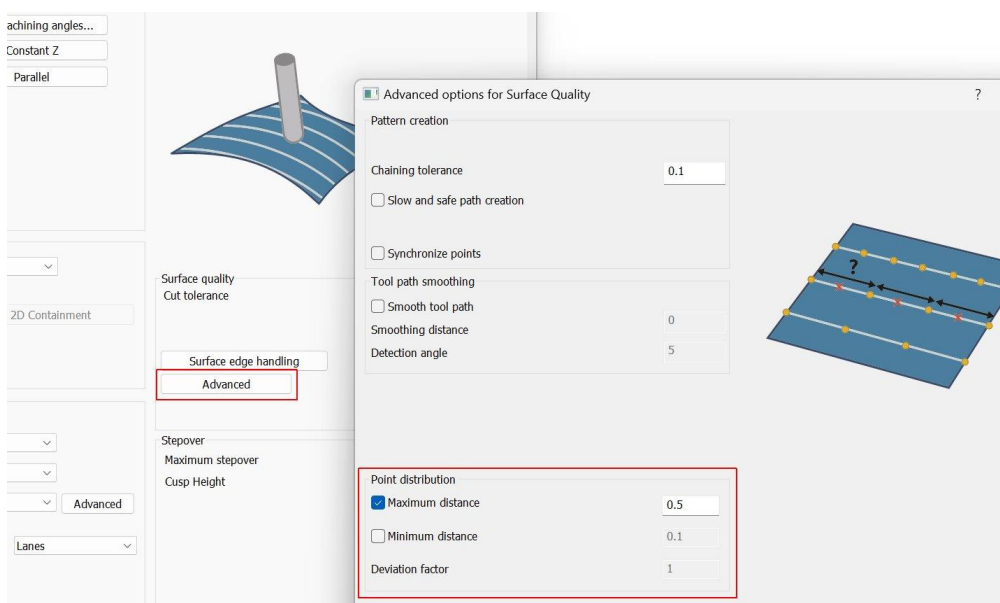

9551: Linking: The UV passes linking could hang if horizontal lead arcs were selected for vertical passes. This has been fixed.

9564: Turning: There was a problem when calculating the offset for a round shape insert, this has now been fixed.

9565: Drilling Cycles: There were occasions when the final peck on a thread milling cycle was being output as a single vertical move when it should have been a complete helix move, this has now been fixed.

9571: If a directory with many subdirectories was specified in 'Options > Post Processor > Post-processor directory', DEPOCAM crashed if you went back to Options again. Now the directory path can be of any length.

9581: Machine Simulation: There were occasions where DEPOCAM could crash if invalid folder selections were made and the simulation was started, this has now been fixed.

9582: Turning: There was a problem generating turning roughing passes, sometimes there is an intermediate pass missing, this has now been fixed.

9586: Boundary Projection: Projecting a boundary onto a surface now copes with edited boundaries correctly.

9588: Stock Model: The defaults for the tool elements being used to remove material have been improved.

9589: UV Passes and Five-Axis: It was possible for a surface folder containing RAW or STL (triangles) surfaces to be used for UV passes or five-axis machining, however the plan would fail with no message. This has now been fixed and displays a pop-up message.

9594: Post Processing: There was a problem, when you select for example 3 toolpaths to post process, then remove one from the Toolpaths list in the Post Processing dialog and post to individual tape files causing DEPOCAM to crash. This has now been fixed.

9595: Linking: Fixed an issue with linking (minimal vertical retract) heights for roughing passes which meant the retract could skim the surface of machined slices. This includes a new 'Clear slices by' parameter in the linking.

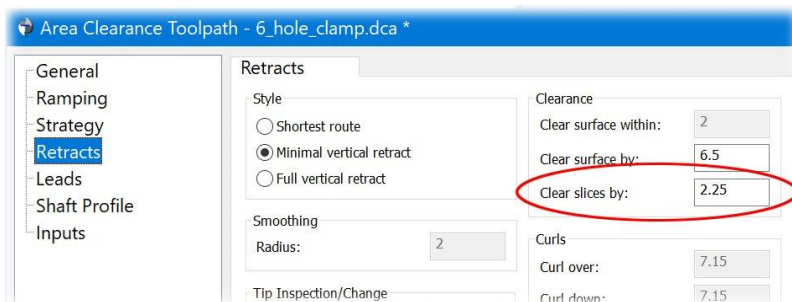

Here is a complete explanation of what has changed since version 19.0.05 and what the new parameter 'Clear slices by' does.

What has changed is the way the rapid moves in a roughing toolpath are carried out over the highest point of the part. In addition, the 'Clearance plane' has an expanded function, also for finishing toolpaths.

There have been requests to reduce the retract height in some cases, it was more noticeable when big stepdown is used. Here is an example to explain the changes.

The area to machine at the part below is Z30 to Z0. A thickness of 1 is used. So the machining takes place from Z31 to Z1. The first machine slice goes completely over the top of the part. This first level is discarded in the linking process.

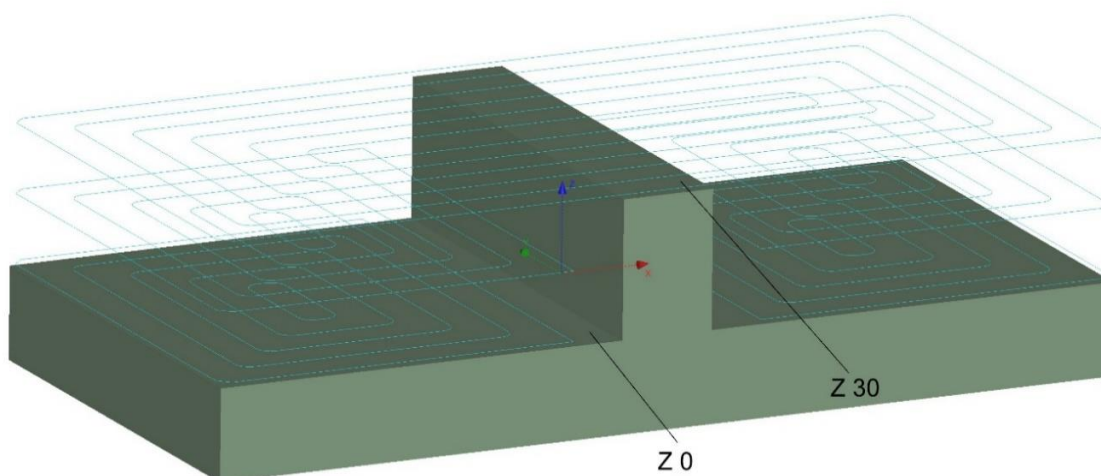

In v19.0.04 and earlier versions, the linking would look like this.

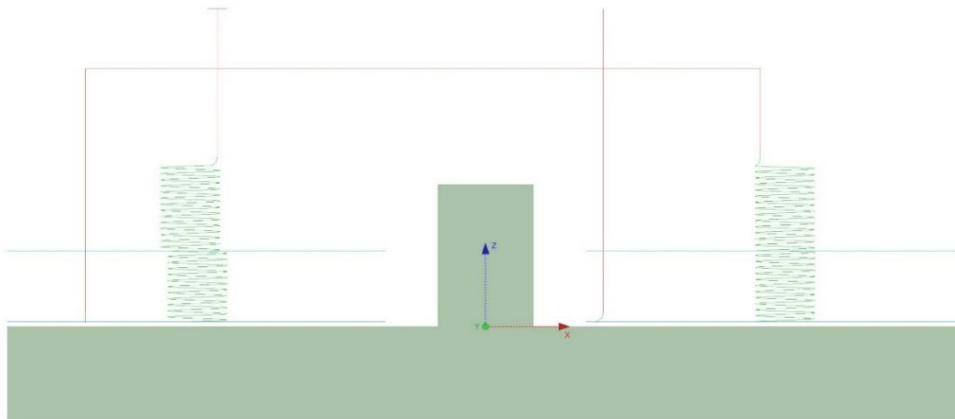

The rapid move from one side to the other is very high above the part. This is because the 'Clear surface by' value is applied to the top of the part. You could not change that, as the 'Clear surface by' value cannot be smaller than the 'Stepdown'. This is for safety reasons, as within the part there can be remaining material of the stepdown height during the roughing operation. Lowering the height of the 'Clearance plane' would not change anything. As there is no material above Z31, it is not necessary to retract so high.

With the latest linking changes, the 'Clear surface by' value is no longer applied to the top of the part, if the first slice of the passes covers the whole area. Like in this example.

The default linking in v19.0.07 looks like this.

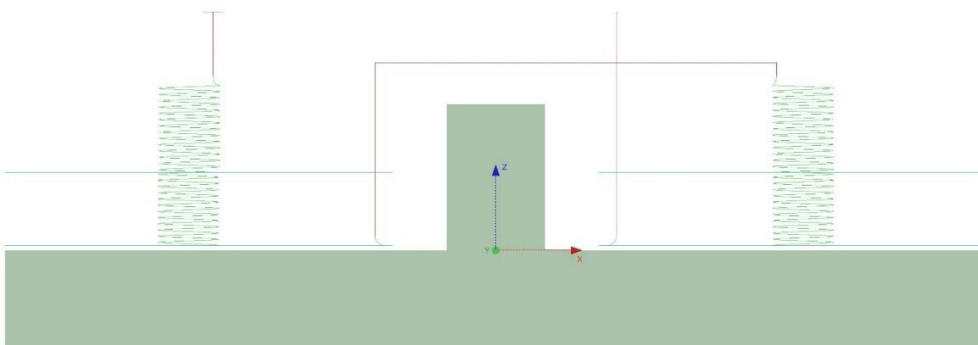

To control the distance at which the rapid move goes over the top, there is a new parameter on the Retracts page in the linking dialog, **Clear slices by**.

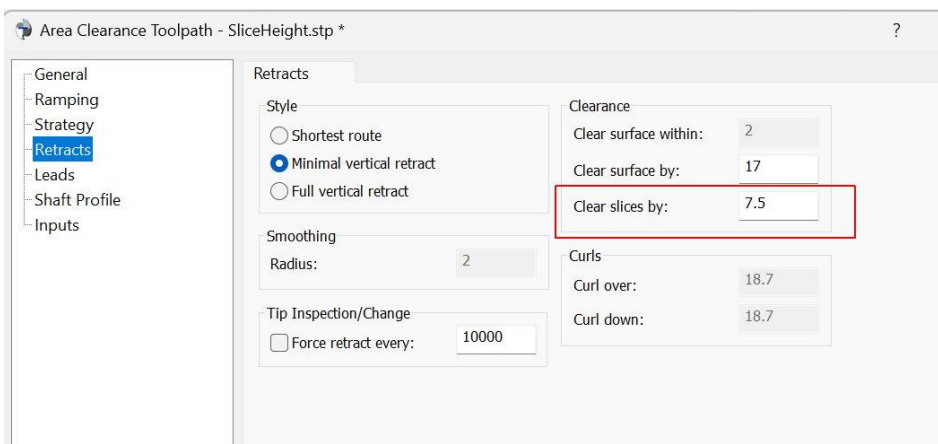

The value of 'Clear slices by' is by default, half the 'Stepdown' value, but not less than 1. The 'Clear slices by' value can be changed to a lower value, but not greater than the 'Clear surface by' value itself.

Since the linking in the toolpath image above uses the default values. We have a 'Ramp height offset' of 3 and 'Vertical Leads' of 2. Setting the 'Clear slices by' to 1, it will not achieve that as it cannot be lower than the start of the lead in, as shown below.

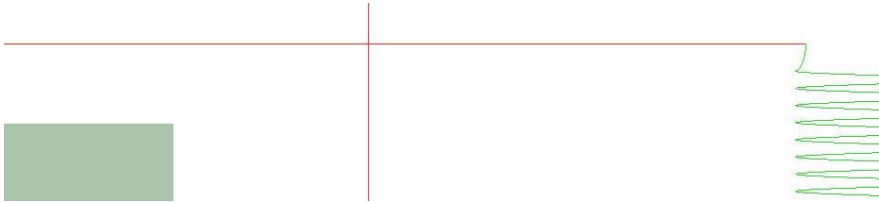

Setting the Ramp height offset, Vertical leads and the Ramp extension all to 0 (which you should not do, as the cutter rapids onto the material) the tool rapids at Z2 over the part with a 'Clear slices by' value of 1. (1+Thickness of 1). See the following image.

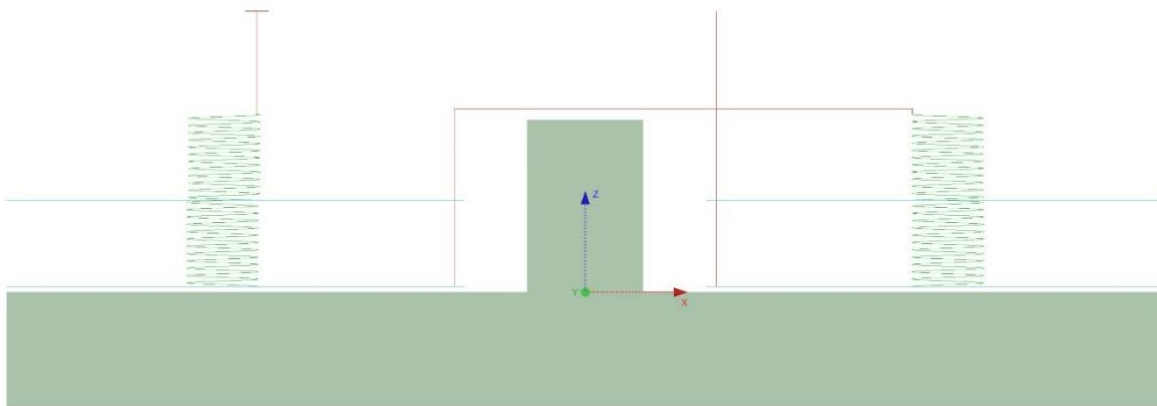

Below is the same machining as above, but this time it starts at Z30 instead of Z31. Because of the thickness the first slice of the passes longer covers the whole area, but is divided into two areas.

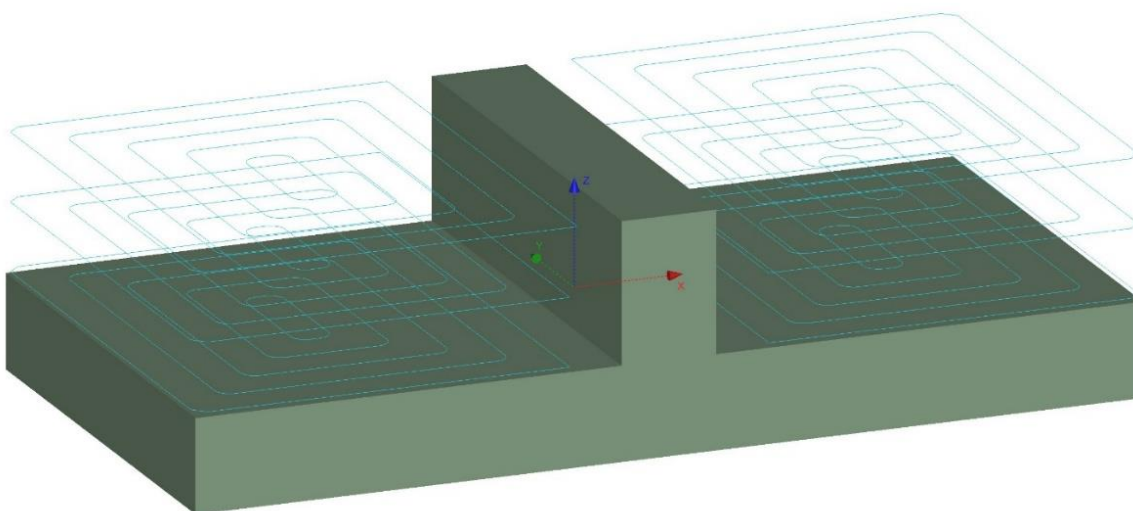

As the software no longer “knows” what is happening at the top, if you link the passes, ‘Clear surface by’ is therefore also applied to the top like it was in earlier versions.

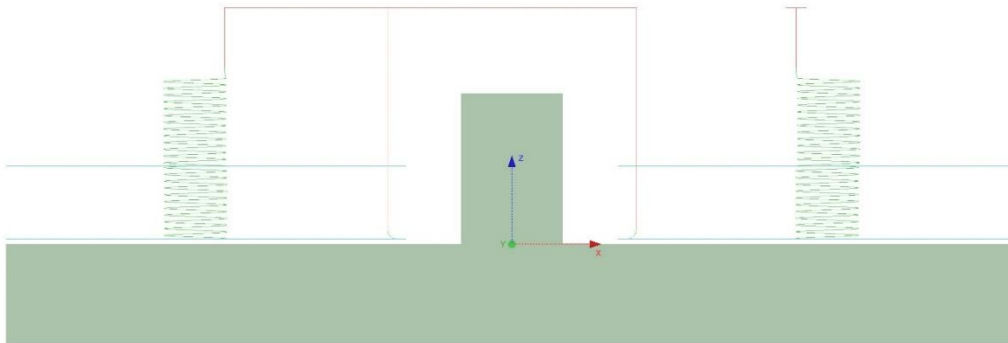

But there is a difference now. Before changing the ‘Clearance plane’ to a lower level did not change anything to the retract height. Now you can bring the retracts down by changing the Clearance plane to a lower level. As user you know whether this would be safe or not. Again, the rapid connection move does not go lower than the start of the lead in move. As in the following mage.

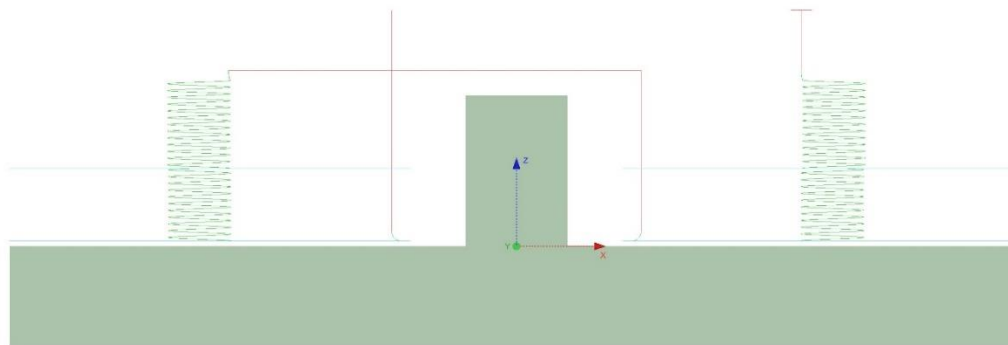

**Important:** If the ‘Clearance Plane’ is set lower than Z Max of the part, which you should not do, the component will not be gouged, but the cutter may scratch over the highest point. This applies to all strategies, not just roughing.

While there appears to be a lot of possible settings now, as usual, if the defaults are maintained, it will be on the safe side.

9598: Post Processing: It was possible to remove all the toolpaths from the list on the inputs page, this should not be allowed and has now been blocked.

9601: Linking: There were cases when linking a Shaft Profile plan derived from Core Roughing passes could sometimes crash DEPOCAM, this has now been fixed.

9603: Surface Trimming: Fillet surfaces can't be trimmed with a boundary - the plan will fail, with the message “Trimming fillet surfaces with a boundary is not supported” will be displayed in the database window, Before it was failing to trim and creating an error report.

9606: User Interface: There were situations when interactively creating boundaries and using the Shift + Ctrl left mouse sequence would cause DEPOCAM to crash if Esc had also been pressed, this has now been fixed.

9609: Fixed an exception that could occur when generating rest area clearance passes.

9616: Turning: There were cases where the linking moves for roughing passes could gouge, this has now been fixed.

9620: User Interface: The context menus for selecting Passes & Surfaces with optional Points has been improved to include the Linking option.

9620: User interface: If a folder with surfaces is also selected in addition to a folder with passes, the context menu now offers 'Link Passes...'. Previously the linking always had to be chosen in the ribbon menu if surfaces were selected as well.

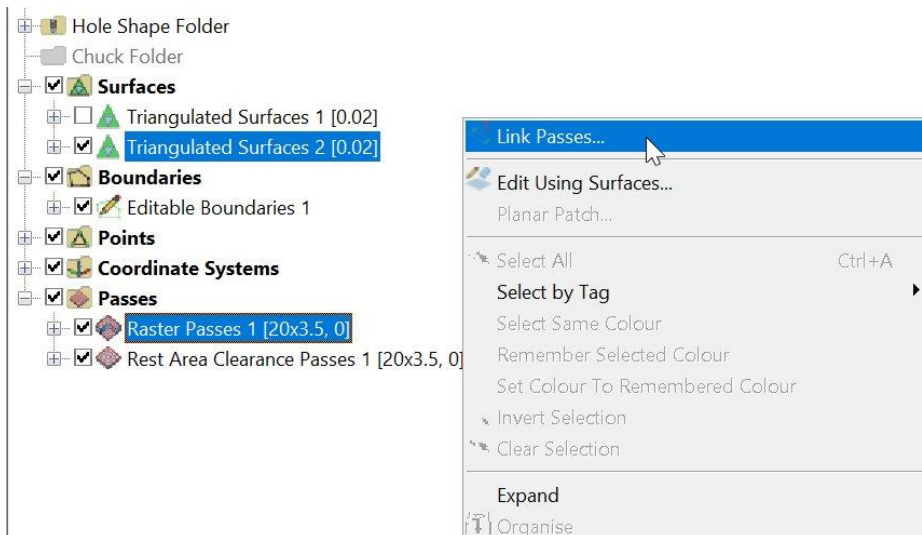

The possibility of selecting a surface folder when linking is not new. Anyway, here is an explanation of what it does.

In the image below, a planar patch surface has been created (green surface). The folder containing this surface has been selected along with the passes to be linked. In the area of the green surface the retracts go up to this surface. The other areas are linked normally.

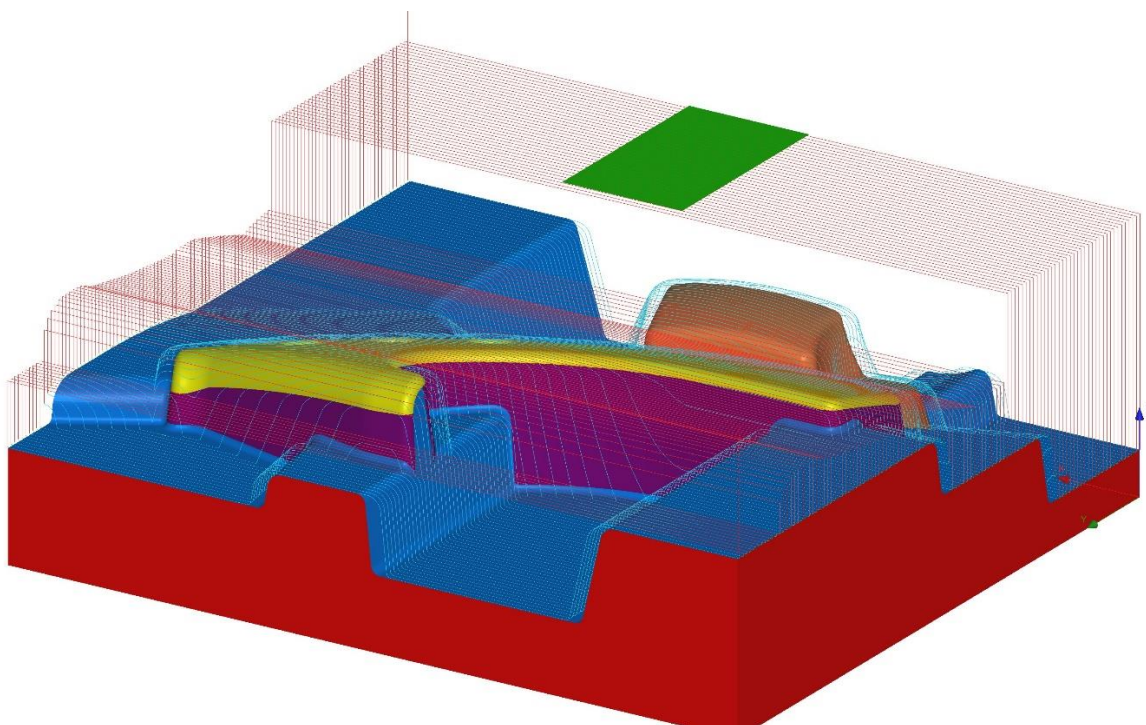



9621: Project Settings: There was a problem saving the default profile to a dca file causing the Options > Default to be used instead, this has now been fixed.

9625: User Interface: The preview image of Tapered Barrel cutter was not maximised correctly in plan dialog or the Tool Database, this has now been fixed.

9626: Security: Fixed network dongles not being usable when launching the application on the machine that the dongle is plugged in to.

9630: Five-Axis: Flank Machining would allow the definition of a Lens cutter to be used. This is not supported and has now been blocked.

9638: User interface: The Gouge Protection page in the dialog tree for Cycles is now on the main level and no longer below the Tool page. This means that the position in the dialog is now consistent with the Machine Along Curve dialog.

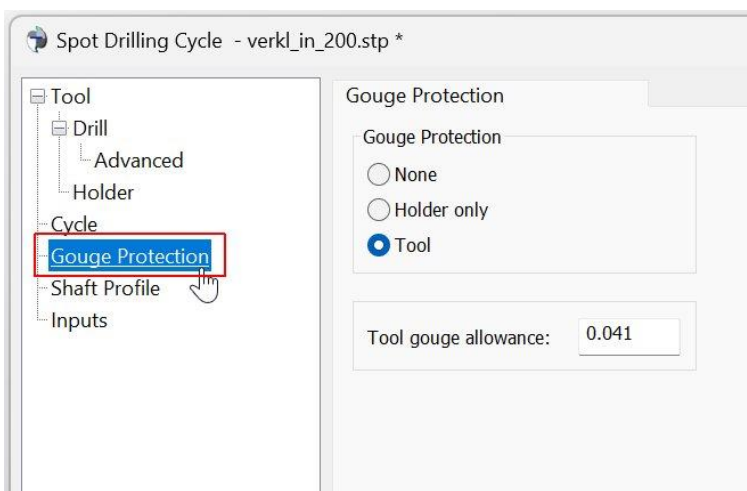

9639: Post Processor: ISO & Siemens: Added the following four options, 'Feedrate variable list Rapid comment', 'Feedrate variable list Ramp down comment', 'Feedrate variable list Cutting comment', 'Feedrate variable list Ramp up comment' to allow a comment to be output with the feedrate variables if used and defined in the NC tape file. There is no default comment set, so exiting post processors will not be affected.

Macros

Post processor: ISO

Parameter	Formula
289 Cutting feedrate	"#3"
290 Ramp up feedrate	"#4"
291 Feedrate variable list Rapid comment	""
292 Feedrate variable list Ramp down comment	""
293 Feedrate variable list Cutting comment	""
294 Feedrate variable list Ramp up comment	""
295 Non-Modal feedrates	false
<b>TOOL CHANGE SETTINGS</b>	
296 Output tool change	true

9643: Linking: The linking of core horizontal area passes differed significantly after simple manual editing. This has been corrected so that the linking is now the same for edited and unedited passes.

9646: Post processor: ISO: Added the option 'Output the diameter offset with the height offset' which if set true allows the diameter offset to be part of the height offset block. By default, this option is false, so existing post processors are not affected.

9647: User Interface: Improved the Advanced tool pulldown list for Five-Axis machining. Now only the tools types are shown which can be used with the chosen Five-Axis strategy.

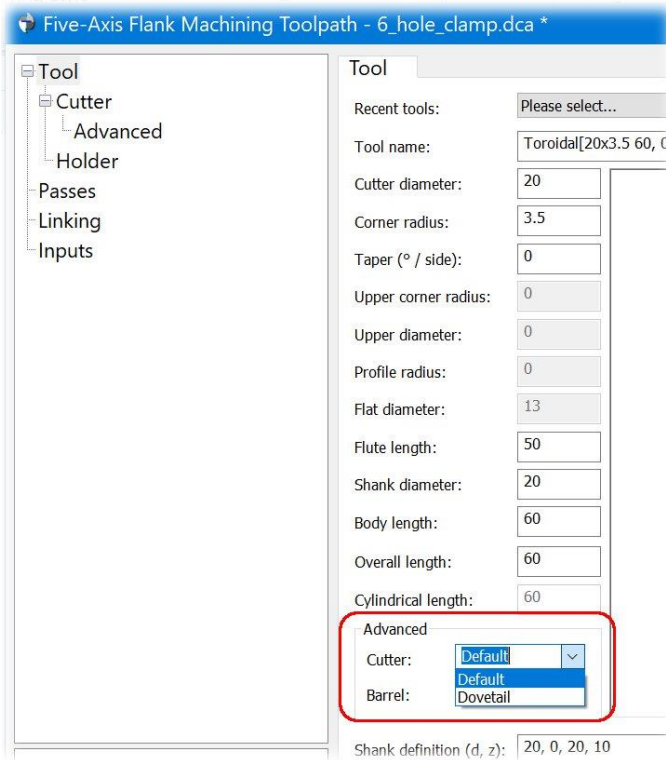

9651: User Interface: If calculations for the were carried out in a dialog, such as 3/2 in the picture below, the result was converted to integers and the decimal places were omitted. Now the result is correct.

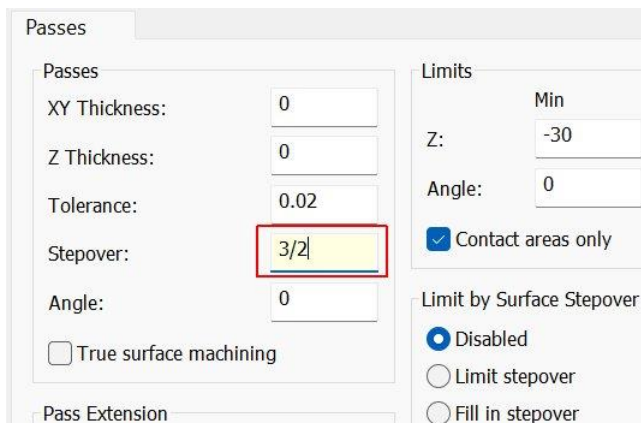

9652: Five-Axis Swarf: An option has been added to the ModuleWorks advance dialog to allows edge curves to be selected or changed.

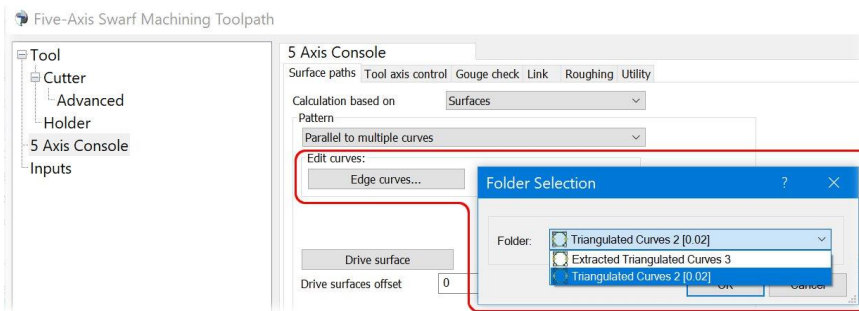

9656: Adaptive Clearance: With UV Direction Surfaces selected, Adaptive Clearance was a selectable toolpath and would cause the plan to fail. This has now been fixed.

# Release Notes for DEPOCAM v19.0.06

24th January 2024

This point release covers several little improvements, along with several fixes to existing features.

## General

6689: User Interface: Fixed a problem with the licence expiry message box being moved behind the main application window.

6851: Five-Axis: We now support tilt option to tilt through lines (curves) for Parallel cuts plan.

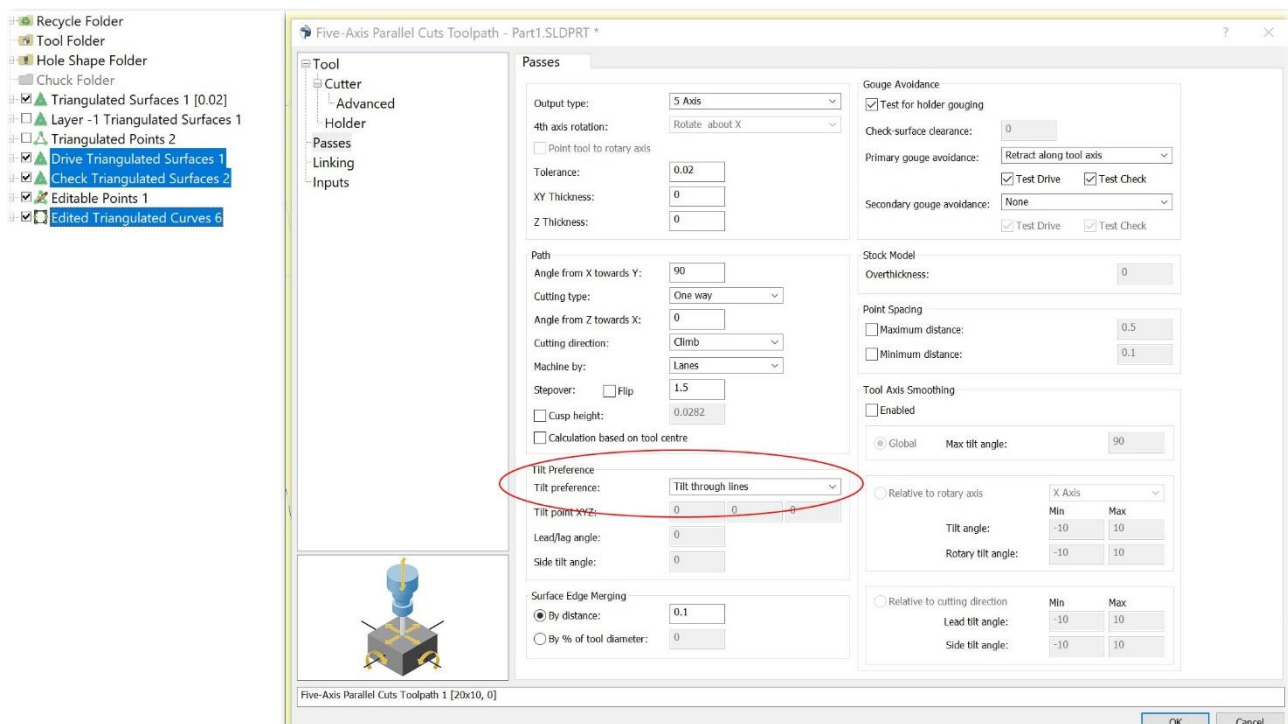

8521: Stock Models: Added the 'Material Removal' section to the dialog. It is now possible to select the tool sections to use when creating a stock model flute/shaft/holder, this is only available when creating a closed stock model.

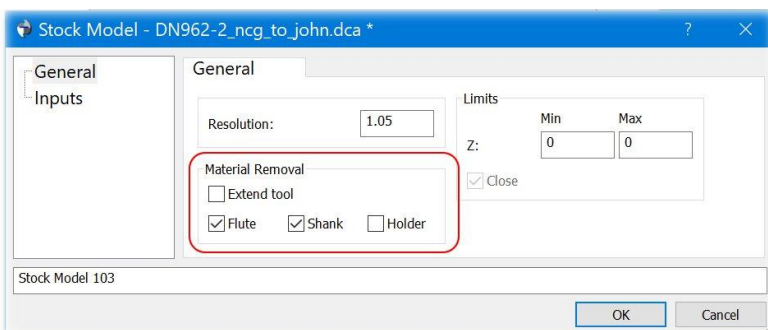

9038: Turning profile pass: There were examples which did not create profile passes correctly, this has now been fixed.

9221: User Interface: The colour of text in the tree view for selected items now changes to suit the back-ground colour. If the selected colour is light, then text will be shown in black, not white.

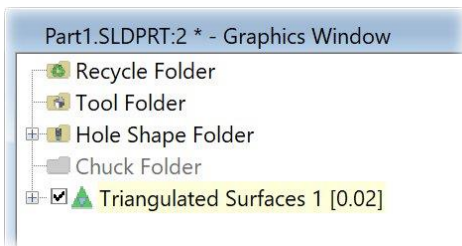

9365: User Interface: With 'Select All' in the context menu, or the keyboard shortcut Ctrl-A, all subfolders in a folder can now be selected. For example, to select the folders for a post-processor run as shown in the picture below. The selection order corresponds to the order of the folders in the tree.

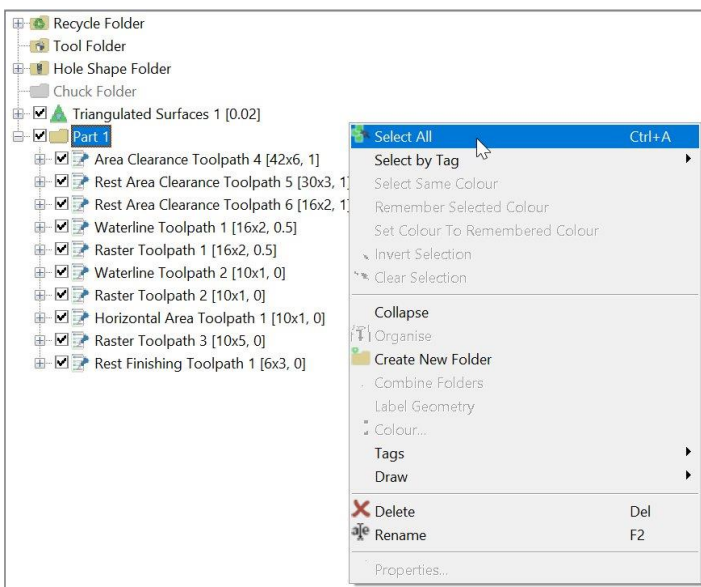

9431: Tool Sheets and Post Processor: There was a problem with incorrect tool details being out for Canned Cycle Tools, this has now been fixed.

9435: Turning: It is now possible to use a Turning Stock Model plan as input to a Face Passes plan.

9440: User Interface: Fixed input boundaries to Constant Stepover Passes being always drawn by default.

9443: User Interface: The context menu for rest roughing was not always being displayed correctly if a tool was selected from the tool folder, this has now been fixed.

9444: User Interface: Added an option to the preferences page that controls whether empty organisation folders are deleted automatically.

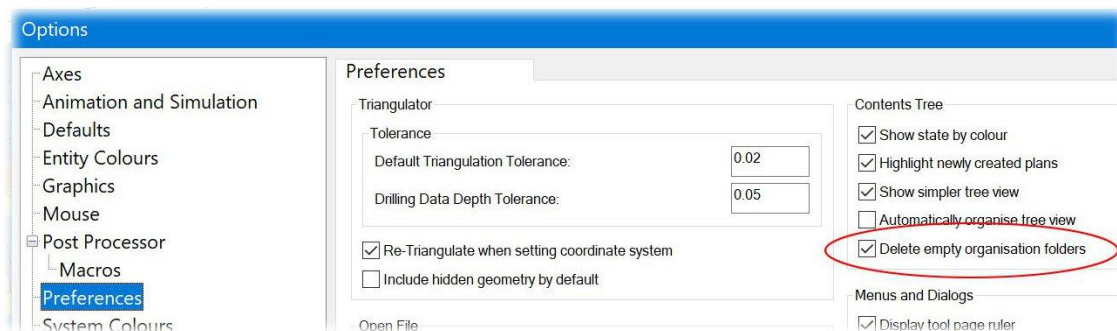

9445: Geometry: There was a problem with Internally Trimmed Surfaces not trimming correctly, this has now been fixed.

9446: User Interface: The 'Create New Folder' option can now be used on the automatically created organisation folders to create nested organisation folders.

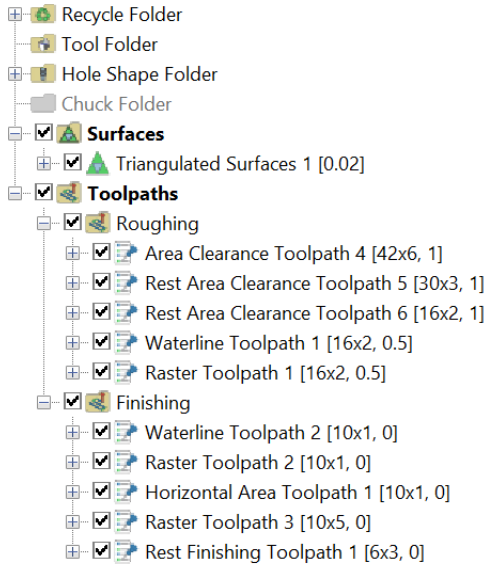

9453: Five-Axis: The advanced parameters for flipping step-over and point distribution have been added to the DEPOCAM dialog.

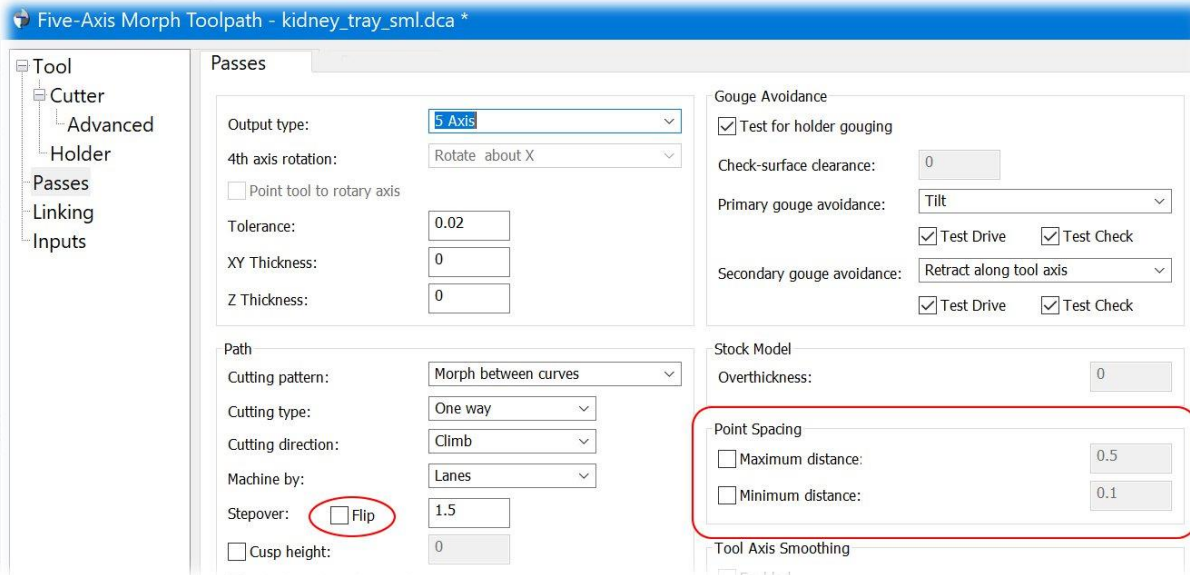

9454: Five-Axis - The current tool is now always updated into the MW Advanced dialog to ensure correct options are enabled and updated, for example the cusp height value is updated when cutter is changed.

9457: Linking: For Area Clearance, Core Roughing and Zig Zag roughing linking we now set a default ramp extension of 2mm if the vertical lead in arc radius is set to zero.

9460: Five-Axis: The advanced parameter for the machining area option (Lanes and Regions) has been added to the DEPOCAM dialog.

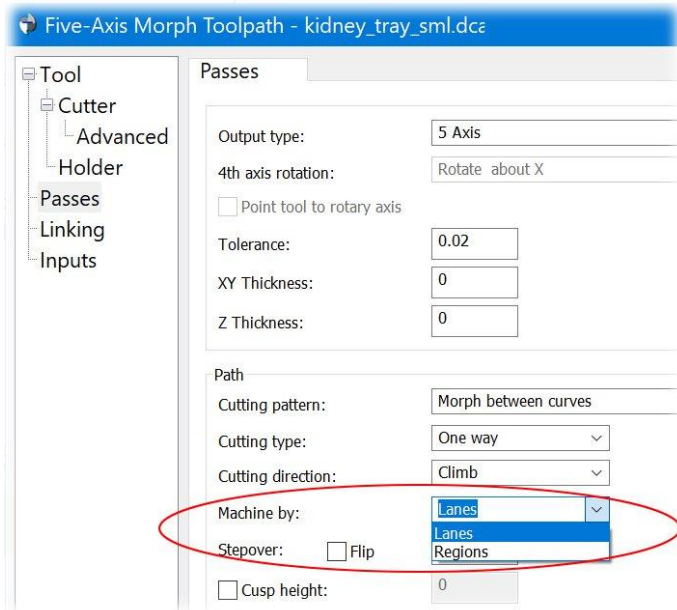

9461: User Interface: The tree view was enabling Milling Edited passes when in Turning mode, they should be disabled, this has now been fixed.

9462: User Interface: Plans can now be moved to the end of the tree view when holding the shift key.



9463: Editable Toolsheet Builder: Fixed issue where multiline tool comments were added to the previous comments.

9465: Five-Axis: Advanced smoothing parameters have been added to the DEPOCAM dialog. It's only available for Ball nose and Lolli-pop cutters.

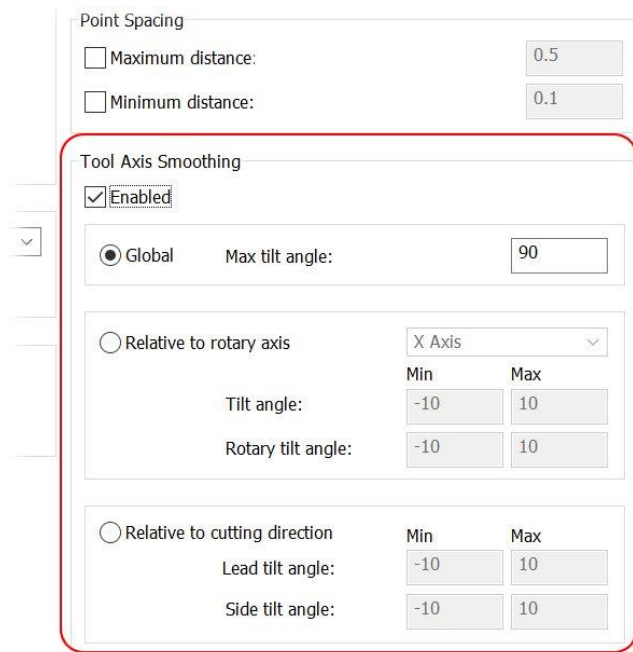

9467: User Interface: Tool Folder - The labels for the tools in the folder now only comprise of the tool name, the 'Milling tool', 'Turning tool' text is omitted.

9468: User Interface: An option to sort the tool folder has been added to its context menu.

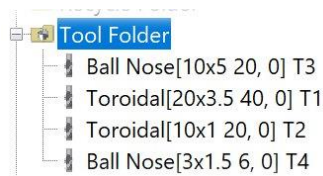

The un-sorted list of tools.

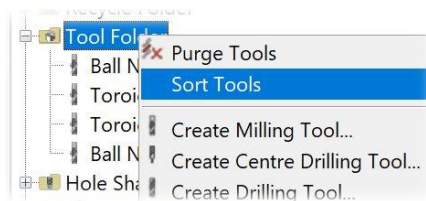

Sorting the Tools Folder.

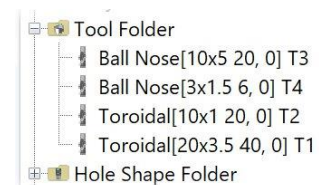

The list after sorting.

The ordering is alphabetical on the name, with upper case before lower case.

9478: Boundaries: There was a problem using 'Combined Boundaries' option with boundaries that have rotations not honouring the rotations correctly, this has now been fixed.



9476: Linking: If roughing passes are linked, the basic setting is to plunge in via a helix. The helix is usually placed over a pass profile. If it is a narrow pocket so that no helix can be placed between the inner pass and the outside of the pocket, the plunging switches from 'Helix ramping' to 'Profile ramping'. If the profile is very small in the middle, it has resulted that the cutter is plunging in a very small area. Which is a problem, particularly for cutters with inserts. If there is no room for a helix above a pass, the Helix is now placed in the middle of the pocket.

Below were the same passes linked in 19.0.05 and 19.0.06. On the left, the plunging takes place on a very small profile; on the right, the helix is placed in the middle, with a connection move to the small profile.

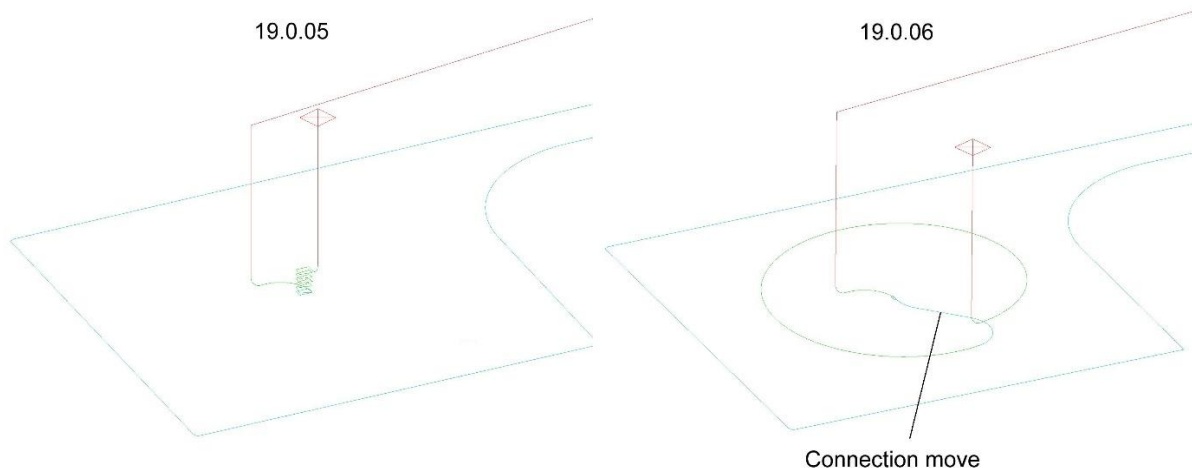

9479: User Interface: Edit: Folder by Colour and Folder by Layer: It is now possible to display the dialog using the Ctrl key. Giving access to the following dialog.

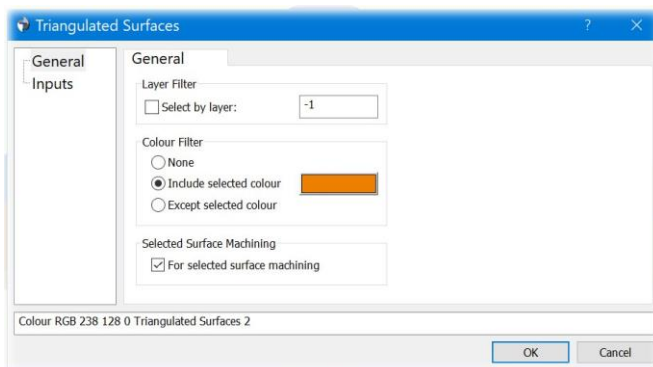

9480: Five-Axis: The option to define machining stepover by cusp height has been added to the DEPOCAM dialog.

9481: Turning: There was a problem where some conical surfaces were being detected as cylinders, causing the passes to be created incorrectly, this has now been fixed.

9482: Interactive Tool definition: There was a problem where some boundaries do not activate the import to definition button, and did not indicate the error, this has now been fixed.

9486: User Interface: Fixed a potential system crash when selecting a drilling data top folder plan with an empty input.

9488: Five-Axis: The options to set Surface edge merging have been added to the DEPOCAM dialog.

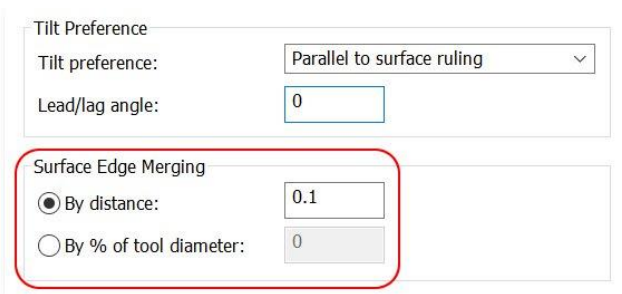

9489: Inspection: It is now possible to convert Inspection Vectors to points in the same way you do for Drilling Data. Points > Convert to Points.

9491: Tool Folder: It was not possible to create a Dovetail tool in the Tool Folder, this has now been fixed.

9492: User Interface: The status bar RGB display is now set when selecting raw surfaces.

9495: Machining: There was a problem where using Raw Surfaces for Selected Surface Raster passes could cause DEPOCAM to crash, this has now been fixed.

9496: User Interface: Fixed nested folder plans not updating correctly.

9497: Five-Axis: The advanced parameter for "calculation based on tool centre" has been added to the DEPOCAM dialog.

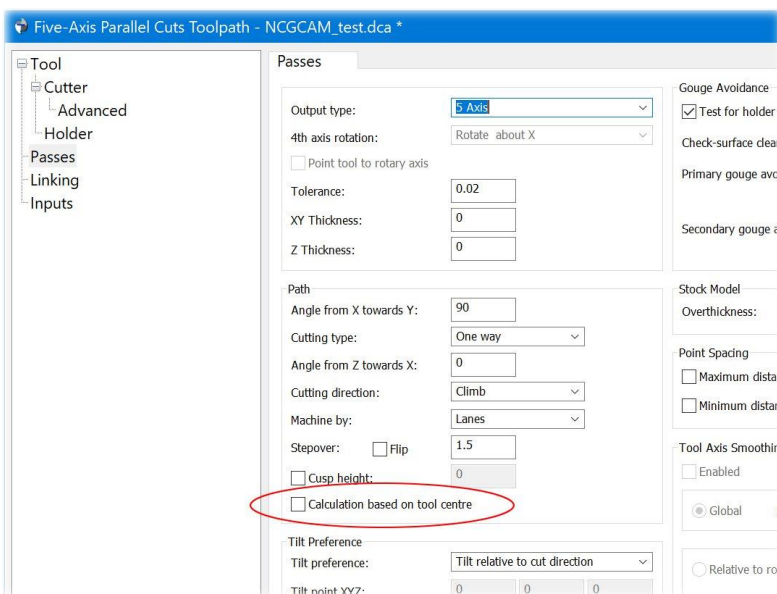

9498: User Interface: Fixed a performance regression when manipulating large stock models in the graphics view.

9507: Stock Models: We now create ModuleWorks stock models when the "Closed" option is set for single axis toolpaths.

9509: Import: There was a problem when trying to load an empty geometry file causing DEPOCAM to crash, this has now been fixed.

9510: User Interface: The 'Drilling Data' entity colour is now opaque by default.

9513: Curves: There was a problem selecting an STL triangulation for the Extract Curves option causing DEPOCAM to crash, this has now been fixed.

9518: Stock Models: There was a problem creating a stock model of a Centre Drill toolpath with the default settings where the plan failed, this has now been fixed.

9521: Five-Axis: The "Tilted with fixed angle to surface normal" tilt axis preference option has been added to the Five-Axis plan dialogs. There is one limitation in that the only way to set the Reference Surface in the plan is via the Inputs page or the ModuleWorks advanced dialog.

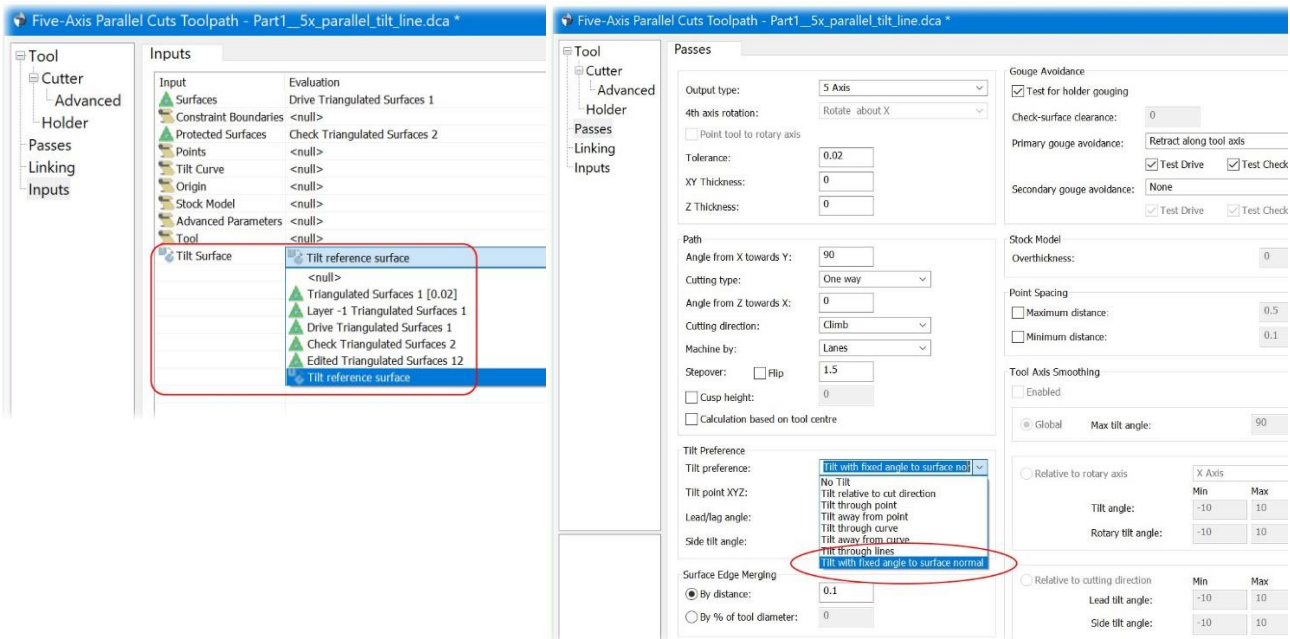

9528: Turning: There was a problem when calculating profile passes, when the input curves has overlapping vertical curves, this has now been fixed.

9531: Rest Roughing: When calculating the Z-Min/Max values for machining, the heights of the stock model is now also included. Previously, only the Z values of the part plus the thickness were used. If a stock model is higher than the surfaces, the passes are now calculated by default from the highest point of the stock model for safety reasons.

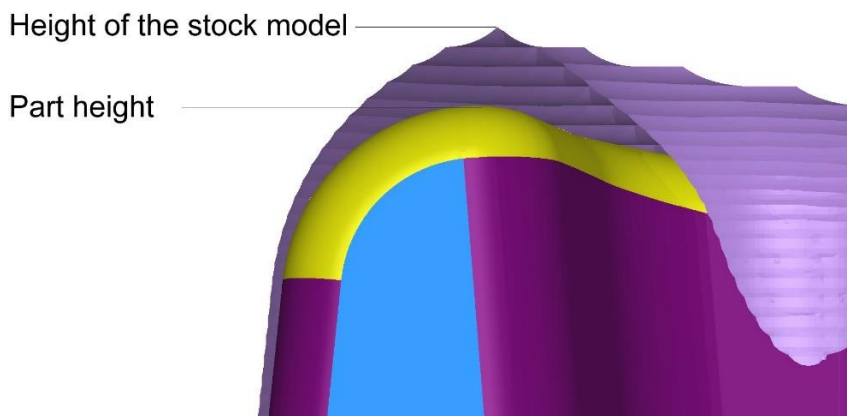

**Please note:**

When rest roughing is performed without a stock model having been previously calculated, a stock model is calculated in the background. It may be that the stock model is not yet finished when the dialog is closed with OK. In this case, if the machining model is higher than the surfaces, the Z value is updated in the background.

This means you are definitely on the safe side. Of course, the above only happens if the default values are left in the dialog. Values entered by the user will not be changed.

9532: Points: There was a problem with Tessellated Points losing their colour attribute when used as input to a plan, this has now been fixed.

9533: Points: Folder by colour/layer will now except a Points Folder as input.

9534: Import: Datakit libraries have been updated to 2024.1. Supports SOLIDWORKS 2024

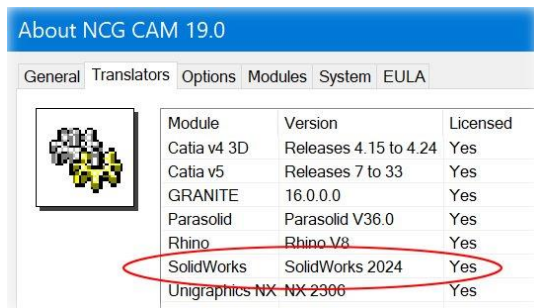

9537: Export: It is now possible to export the shaft profile data from a drilling cycle plan to an excel file.

9540: Cutter Simulation: Two new display modes "Solid" and "Removed Material" have been added, Solid draws simulation in one solid stock colour and Removed Material draws the simulation in 2 colours one for unmachined stock and the other for removed material.

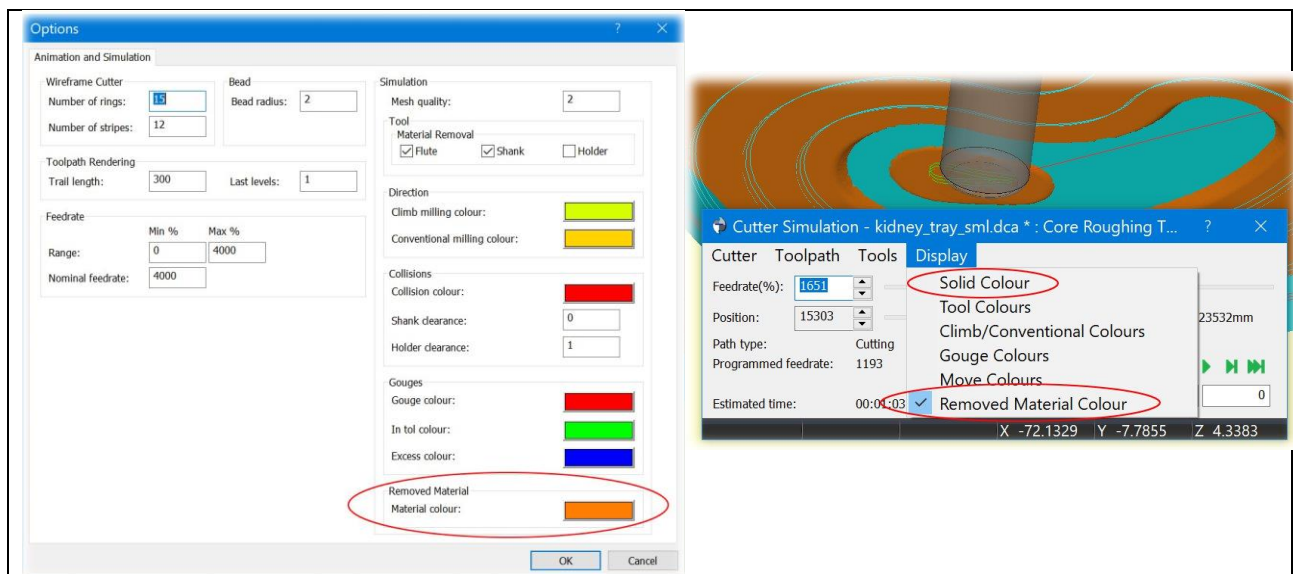

9544: Cycles: It was possible to select the Milling Detect Holes plan to create Drilling Data plans in Turning, this has now been blocked.

9545: All combined boundaries now accept 3D as well as 2D boundaries as input. This fixes a problem in earlier releases.

9552: User Interface: The icons for the tags context menu were not always displayed, this has now been fixed.

9556: Turning: There was a problem when checking whether insert tips are inside the holder, this has now been fixed.

## Release Notes for DEPOCAM v19.0.05

12th November 2023

This point release covers several little improvements, along with several fixes to existing features.

### General

6111: Shaft Profile Analysis: The default sample distance for shaft profile analysis has been reduced from 2mm to 0.25mm to improve the accuracy of the calculation. With the old 2mm default it was possible to mislead you in to thinking that a holder was clear when it could touch the part.

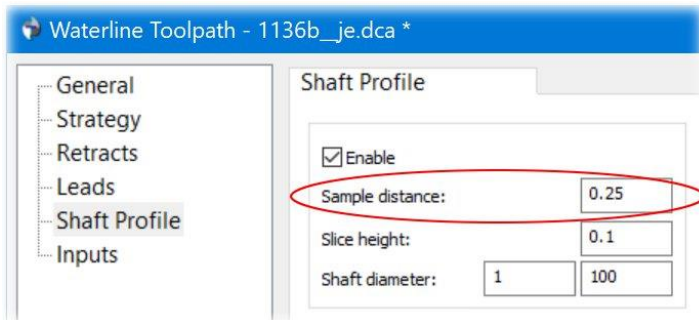

The greater accuracy does increase the calculation time slightly.

8103: Post Processor: ISO: Added the option 'Output the toolchange for every toolpath' for a controller that needed to see the tool change for every toolpath, even if it was the same as the previous tool number. The default is false so existing post processor will not be affected.

8422: Raster Passes: The contact angle trimming of raster passes on vertical walls has been improved.

In the image below on the left, the passes were created before version 19.0.05 and you can see that a small area on the vertical surfaces was left out. In the image on the right, the paths were created with version 19.0.05 and show complete passes.

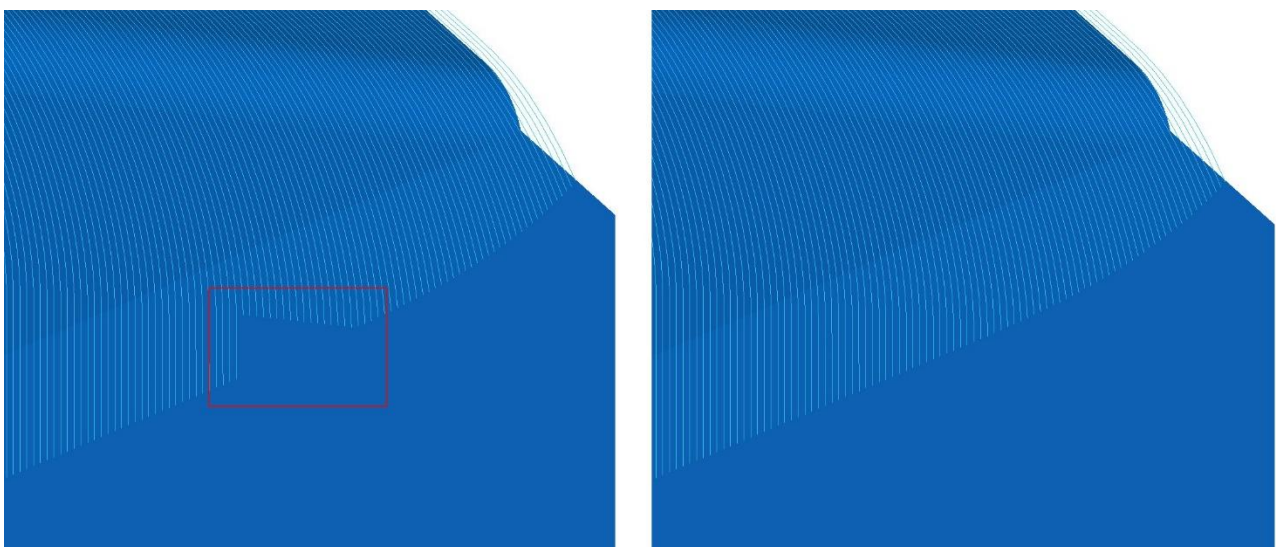

8472: Linking: Fixed a problem that was causing excessive lifting when using the minimal retract option.

8645: Linking: The 'Prefer Order by Offset' has been enabled for edited axially offset boundary and pencil passes. This also fixes ticket 4686.

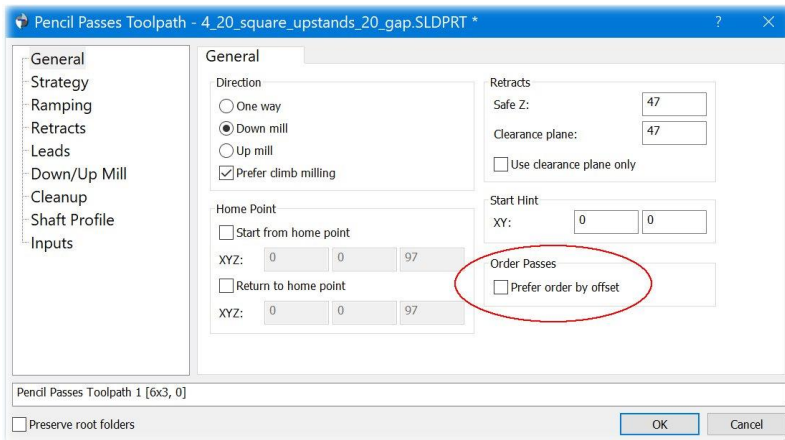

8871: Surface Trimming: A problem has been fixed where the trimming of surfaces with seamed geometries, such as cones and cylinders, could fail.

8891: Selected Surface Waterline: A problem has been fixed where incorrect results could be obtained when the selected surfaces were the product of repeated sub-selections.

8913: ModuleWorks: The libraries updated to MW2023-08, this also fixes ticket 8643.

8948: Surface trimming: The trimmed surface now has a smooth (and more accurate) circular boundary sections with both Keep Interior and Keep Exterior.

8950: Trim Surfaces with Boundary: A problem has been fixed where result of trimming an IGES Trimmed Parametric Surface could be incorrect.

8951: Surface Trimming: A problem has been fixed where selecting "Keep Exterior" could produce the same result as "Keep Interior".

9002: User Interface: An invert tool button has been added to the 3D Tool Guide for turning tools.

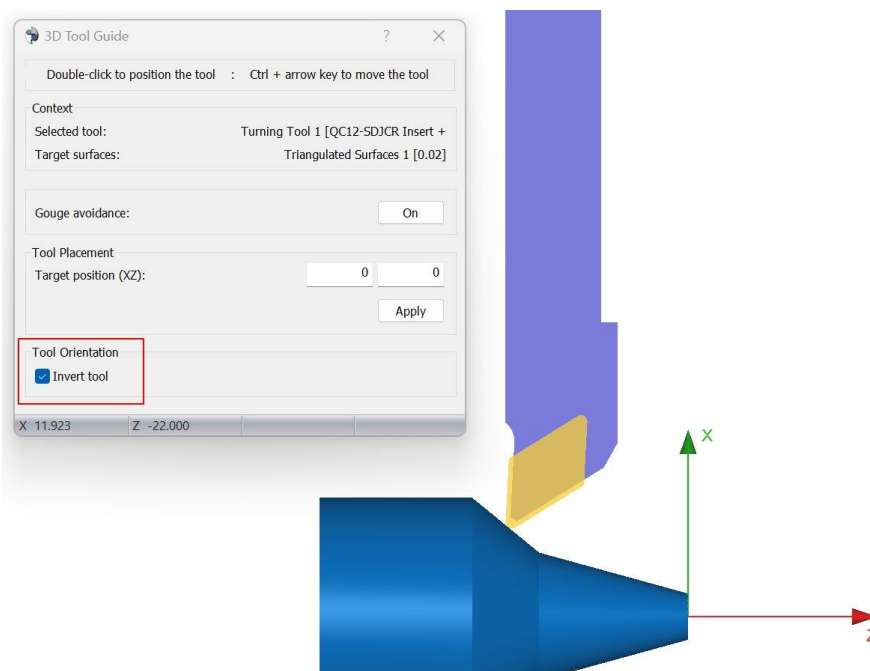

9078: User Interface: An option to set the chuck colour has been added to the system colour page.

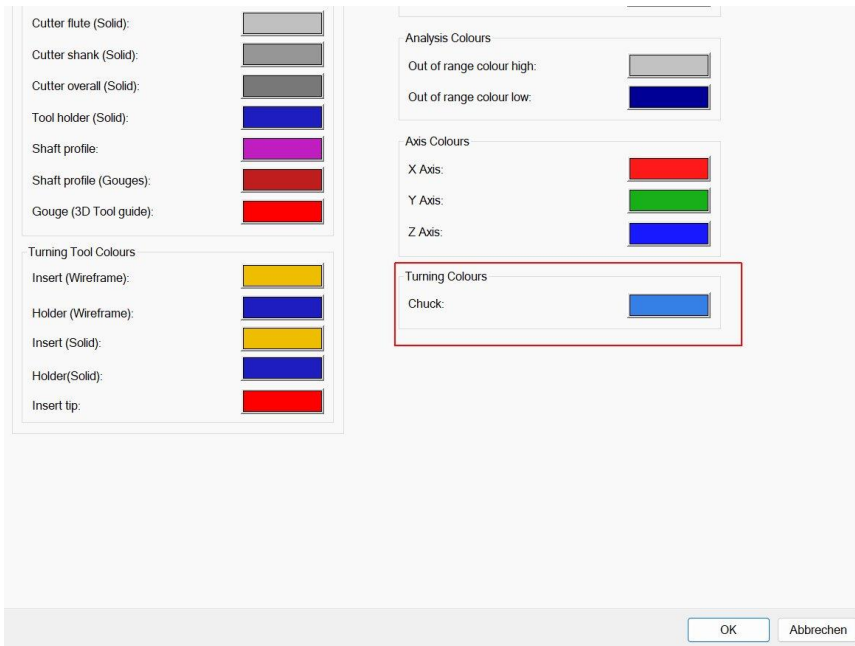

9090: Import: The file loading now has an option to load infinite geometry. If surfaces are written into a geometry file as infinite geometry by the CAD system, they are usually not read by DEPOCAM. If geometry elements are missing after reading into DEPOCAM, you can try to read the file again with the 'Prefer infinite geometry' option to get the missing geometry elements. The 'Prefer infinite geometry' option can be enabled under Options > Preferences, but in most cases it is not required

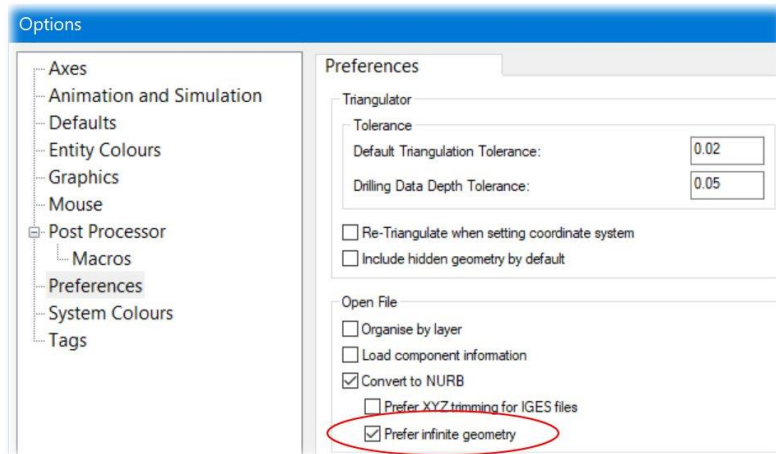

9093: Import: The 'Organized by layer' options for Step and IGES files were not being handled correctly, this has now been fixed.

9101: Turning: There was a problem where some holder definitions were being flagged as invalid, when they were in fact ok, this has now been fixed.

9122: Turning: Trimmed Torus geometry from IGES files was not always being handled correctly, this has now been fixed.

9137: Adaptive Clearance: It is now possible to do Adaptive clearance - rest machining inside a constraint boundary by supplying a stock model and boundary plan. Up to now, the rest roughing has always been carried out completely within the selected stock model. In the picture below, adaptive rest roughing was carried out within a boundary.

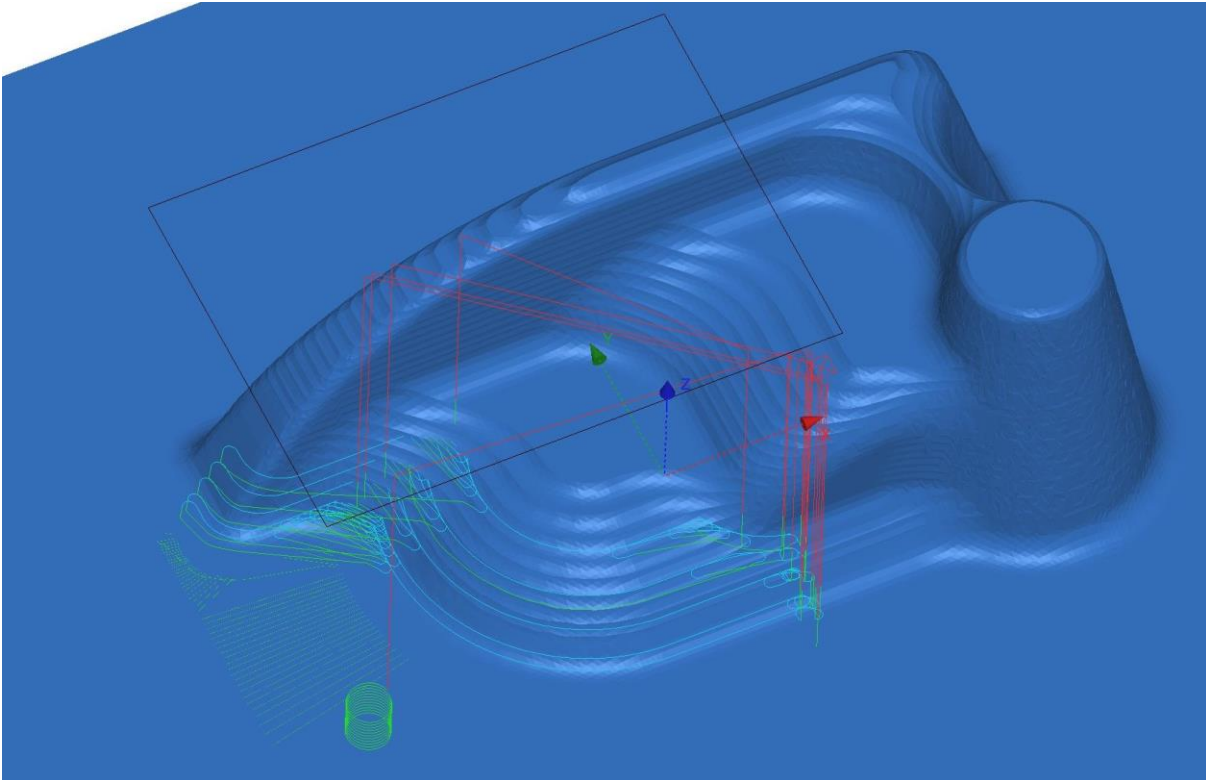

9149: Stock Models: There were occasions when creating Multi-Axis stock models with a tight resolution could cause DEPOCAM to be unresponsive, this has now been fixed by improving the validation of the resolution.

9150: Tool Holder: There was an issue when creating a holder definition with the start point height was close to zero but not exactly zero. This has now been fixed.

9157: Curves: On the View ribbons Display section had 'Levels', the wording has changed to 'Layers', this makes the wording more consistent.

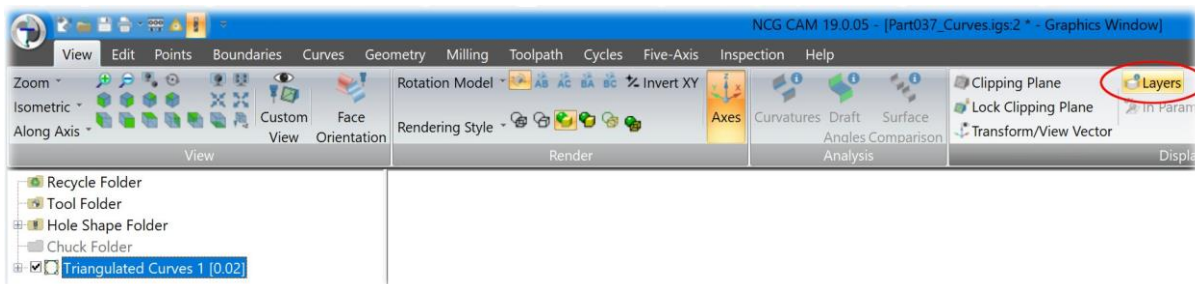



It is now also possible to separate curves by layer.



9158: Post Processors: ISO, Siemens, and Heidenhain: Added an intermittent air blast option. It is dependent on Air external being selected as the coolant type in the cutting parameters. In the Post processor options there are two additional parameters: "Coolant air blast off distance", and "Coolant air blast on distance". Setting the "Coolant air blast off distance" to a value greater than 0 activates it and sets the distance the air will be off for, while the "Coolant air blast on distance" sets the distance the air will be on for. "Coolant air blast off distance" is set at 0 by default so exiting posts are not affected. The distances are not exact, as the check is made on moves in the toolpath.

9159: User Interface: When a database is saved with multiple graphics windows they will now be loaded in the correct order when the dca file is reopened.

9170: Tool Database: When adding a new drill directly in the tool database, it was not possible to change the drill diameter. This has been fixed.

9173: Installer: The DNCManager is no longer installed by default as there is less need for it now. It can still be installed by checking its box on the "Select Components" page of the installer if it is needed.

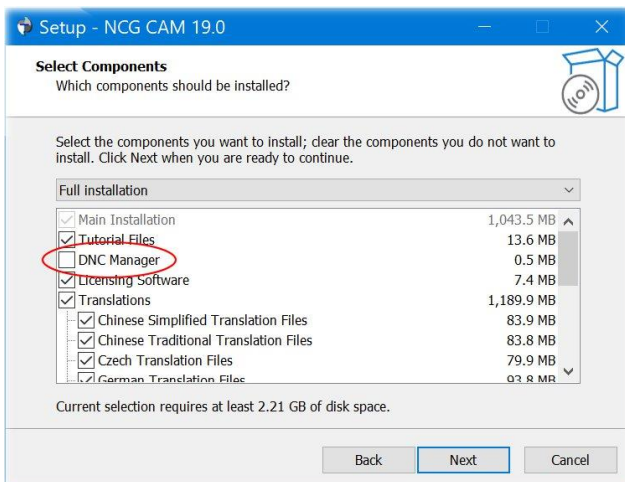

9178: User Interface: Project settings: When the user's full name is not set, display the login name instead for the Engineer's name, and in the database window banner.

9180: Linking: Corrected a thickness addition that was applied to retract moves. Also limit minimal retracts so they aren't higher than full retracts.

9183: User Interface: Fixed an issue when using multiple graphics windows, that could result in all windows closing after saving and closing one of the graphics windows.

9185: Linking: The default formula for Clearance height and Safe Z have been modified so they do not include the Curl over and Curl down radius.

9190: Fixed a hang that could occur when a database archiver runs at the same time as a passes plan. Also fixes ticket 9214.

9192: User Interface: Fixed an issue with all created plans being selected when loading a geometry file.

9198: User Interface: The Z Level graphical guides have been added to the Rest Finishing Passes dialog.

9200: Cutter Simulation: Turning - A toolpath which has a holder defined with zero length segments in the holder definition, it would cause DEPOCAM to crash, this has now been fixed.

9201: Curves: The separate Folder by Colour option is now enabled for curves.

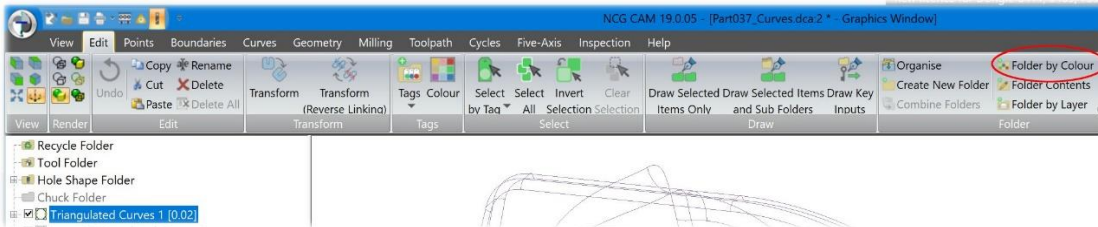

9202: User Interface: Fixed a problem of not being able to open files by double-clicking on them in Windows Explorer.

9204: User Interface: The application name in the Windows Explorer "Open with" menu now includes the version number.

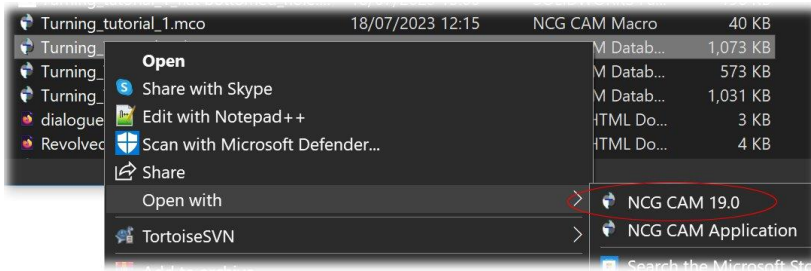

9205: A date string is now always appended to the file names for autosave databases and macros.

9211: Adaptive Clearance: When using pre-drill points the toolpath would not always use them correctly, this has now been fixed.

9212: Adaptive Clearance: There was a problem when using an edited boundary plan as input and then using the ModuleWorks advanced dialogs giving an incorrect toolpath, this has now been fixed.

9218: Linking: Improved the performance of linking edited waterline stepover passes.

9222: ModuleWorks: An option to select stock models from the Advanced dialog has been added.

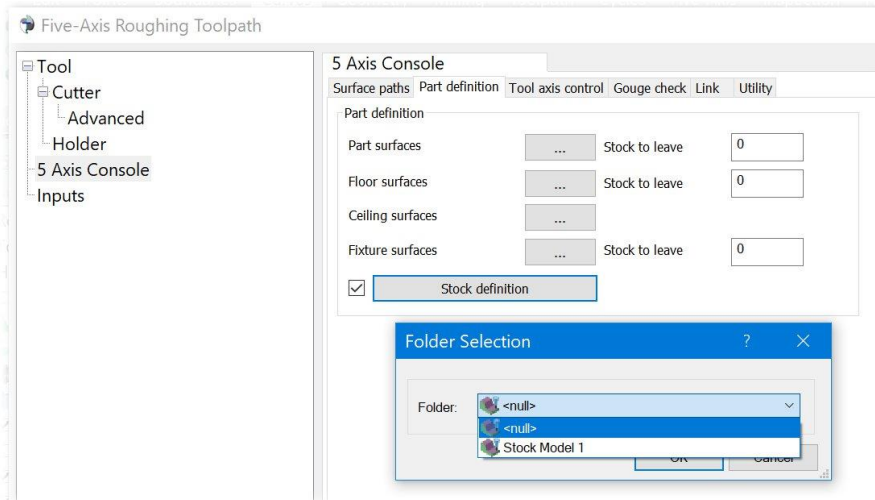

9225: Toolsheets: Fixed an issue that would result in the cutter diameter in the CSV toolsheet toolpath summary being incorrect for drilling toolpaths.

9229: Main: Previously all files over a month old were purged when the number of files in the Program data folders (which by default is: ProgramData\NCGCAM Solutions) became too large, now the oldest files are purged until the number of files has been reduced to an acceptable level.

9230: Main: Fixed a problem with files created in languages other than English not being cleared from the Program data folders.

9237: User Interface: The option to display turning toolpaths at centre or tip has now been activated on the view ribbon, also an option has been added to the Cutter Animation/Simulation dialog to make swapping modes easier.

**Note:** Now that the default mode of drawing turning toolpaths is cutter tip (the same as milling) which is different to how it was displayed previously.

9238: Toolsheet: The CSV toolsheet now correctly supports multi-line Toolpath comments. The cutter compensation side (if any) is now output on a separate line.

9239: Editable ToolSheet Builder: Toolpath Comments field will now accept multiline comments

9240: Toolsheets: Fixed the status bar processing message in the Editable Toolsheet Builder application to show "completed" only when the process has completed.

9241: Editable ToolSheet Builder: The last used template will be remembered and set as the active toolsheet template by default.

9242: User Interface: Fixed a problem with toolpaths not being drawn correctly when translucency is enabled.

9245: Toolsheets: The post-processor name is now included in the output of a CSV toolsheet.

9247: User Interface: Fixed an issue with the ribbon not being updated when switching between graphics views.

9249: Ruled Surface: It was possible for the ruled surface plan to crash when run from a macro, this has now been fixed.

9251: Post Processors: ISO and Siemens: It was possible for a coolant on M-code not to be output if the option "Stop the coolant between toolpaths" was set 'true'. This has now been fixed.

9261: Linking: Retract heights. Fixed an issue that could cause unnecessarily high lifts when using minimum retracts.

9262: User Interface: The example image for turning toolsheets was not being displayed in the dialog, this has now been fixed.

9268: Linking: Link Order for Edited Axially Offset Boundary Passes. Fixed up ordering issues with prefer order by offset.

9272: Import: Curves with colours. We now set both line and arc colours when we import a curve with an associated colour.

9277 and 9269: User Interface: The option on the view ribbon to set the toolpath tip display option is now a gallery. Also has improved icons, with different images for milling to turning.

Milling

Turning



9278: Post Processor: ISO Master: Added options to allow a better master file to be created for a Roeder's machine, Most of the new options are in the "TOOL MEASURE", "TOOL CHECK SETTINGS" and "DYNAMICS" sections, but there are some other like the "Sub program suffix" to allow a suffix to be added after the sub program name call. All are set to be false or "" (nothing) by default, so not to affect any existing master post processor. Updated the help to match when there is more detail of the options.

9279: User Interface: When using the advanced ModuleWorks dialogs for 3 to 5 conversion the Surface paths tab was missing from the dialog, this has now been fixed.

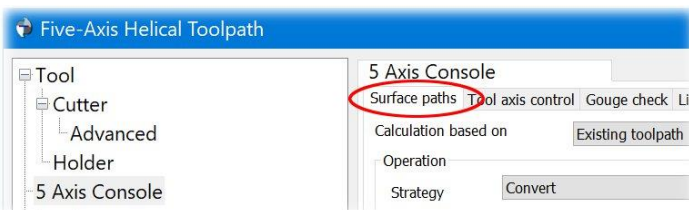

9282: Five-Axis Conversion: An option has been added to the ModuleWorks advance dialog to select a toolpath to be converted.

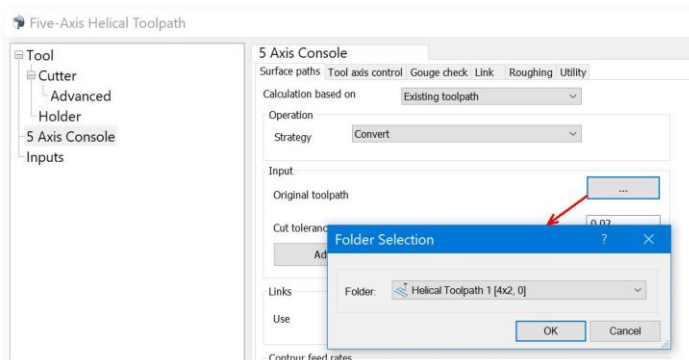

9283: User Interface: Improved the performance when drawing a large number of spheres.

9286: User Interface: Fixed an issue that could cause surfaces being drawn black when using the curvature or draft analysis rendering modes.

9291: Turning: It was possible to get overlapping geometry curves as inputs (especially cones and cylinders) to a turning passes plan, resulting in incomplete passes being created, this has now been fixed.

9295: Postprocessor: A problem has been fixed where changes to the input toolpaths made on the postprocessor dialogs Toolpath page would not be taken into account.

9303: Adaptive Clearance: There was a problem using the Fit to Arcs option on the ModuleWorks advanced dialog giving an incorrect toolpath, this has now been fixed.

9304: Adaptive Clearance: Options to enable Arc Fitting of toolpaths have been added to the DEPOCAM dialog.

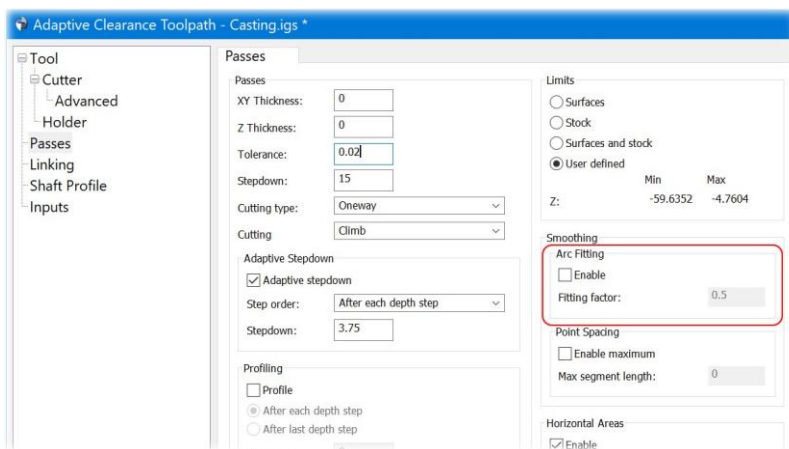

9306: Fixed an exception that could be thrown when setting up machining calculations.

9309: Ruled Surface: attempting to generate a ruled surface with the wrong number of input curves now shows an error message.

9310: Linking: Minimal retracts. Fixed a problem which meant we were linking as if we were outside of the profiles. For example, applying the clear surface by distance, even when a linking move was entirely above the top cleared slice.

9314: User Interface: Fixed an issue with the draw states being set incorrectly when setting the coordinate system of an edited plan.

9320: User Interface: It is now possible to resize the Advanced folder selection dialog from the Advanced ModuleWorks dialog page.

9323: Fixed the issue with DEPOCAM failing to launch on versions of Windows 10 older than 1703 (10.0.15063).

9325: User Interface: There was a problem when creating a points folder from mouse hits with a 2D Stock Model displayed crashing DEPOCAM, this will now not crash, but the 2D Stock Model cannot be used to snap points to.

9328: Geometry: It is now possible to Reverse Orientation of a surface folder without having to select surfaces first.

9329: Geometry: It is now possible to create offset surfaces of a surface folder without having to select the surfaces first.

9331: Linking: Retract Heights. Retract heights and ramp extensions have been improved for profile ramping.

9341: User Interface: Tapered tools were not always being displayed correctly in the Tool Database, this has now been fixed.

9347: User Interface: The ModuleWorks dialog pages can now use the translation set via the program command line.

9349: User Interface: The tool folder is now always enabled regardless of the status of the tools within it, also it was possible to re-run a disabled plan with a double click and control key, this has now been blocked.

9356: User Interface: Fixed selection issue on Intel GPUs resulting in incorrect rotations in the graphics view.

9361: Linking: Clearance heights. The user may now define a clearance plane at any height above the top of the machined surfaces (modified by thickness). Minimal retracts will not go above the clearance plane unless the start and end of the lead moves are already higher.

In the picture below, Area Clearance passes with a stepdown of 20mm were created and linked. The tool moves over the part from one pocket to another at a height of 29 mm. Due to the large stepdown the safety distance is accordingly large. The safety distance is also applied to the top of the component. So far, this height has not been able to be reduced by lowering the clearance plane.

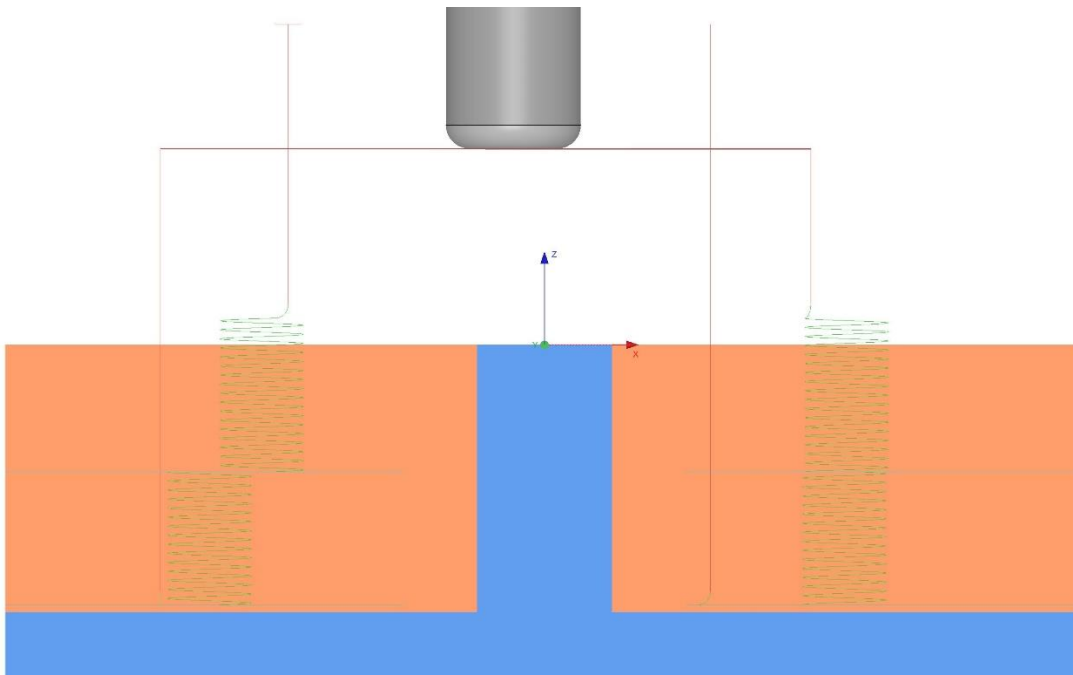

With version 19.0.05, the safety distance is no longer applied to the top of the part. This means that by reducing the height of the clearance plane, the height of the positioning move above the part can be reduced. In the picture below, the clearance plane has been set to 3mm and the cutter is positioned at this height.

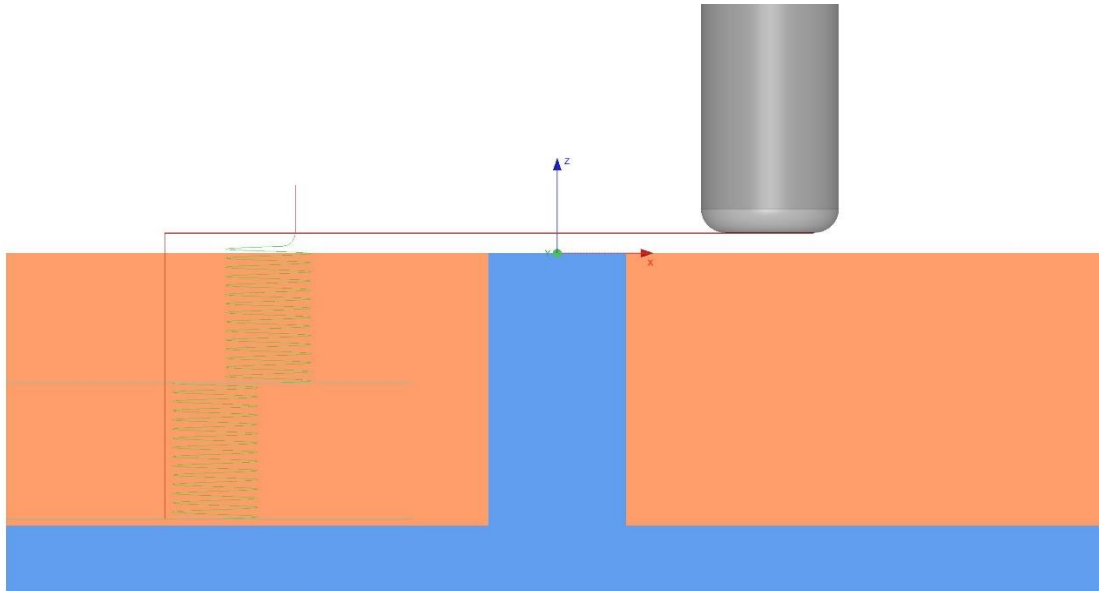

9362: Linking. Waterline Passes: We now limit the start of helical ramps to Z Clearance plus the Ramp Height Offset.

9364: Post Processor: GPost: Added PPRINT lines for the Tape file folder and the Tape file prefix.

9366: Linking: The setup of ramp heights for area clearance linking moves has been improved. This also fixes ticket 9355.

9368: Linking: Fixed an issue which caused 3+2 toolpaths retracts to be discarded.

9370: True Surface Machining: Fixed exception that could be thrown due to bad data.

9374: Linking: The handling of thicknesses when linking over profiles has been improved.

9381: User Interface: Fix dialog sizes for Turning profiling and roughing.

9383: User Interface: Fixed a crash when selecting items in the graphics view when using the default Microsoft graphics driver.

9386: Import: The Datakit libraries have been updated to 2023.4. This supports Parasolid V36.0 and UG NX2306

9390: Turning: There were examples which did not create the passes correctly due to overlapping geometry, this has now been fixed.

9391 and 9424: Post processors: ISO and Heidenhain: Added an option to allow a pre-positioning move before the rotation move. Because of differences in the two controls and post processors, they are described slightly different in the post processor options. For consistency a pre-existing option has been reworded slightly too.

Macros		
Post processor: Hurco		
Parameter		Formula
247	Force rotations to zero between toolpaths with the same rotation	false
248	Text before a vertical toolpath following a rotated toolpath	""
249	Output preposition move before the first rotation line	false
250	Output preposition move after the first rotation line	false
251	Compensate for Rotation on Preposition move	false
<b>TOOL COMP. - ABC</b>		
252	Compensate for tool rotation	false
Macros		
Post processor: Heidenhain 530 BC Plane spatial		
Parameter		Formula
135	Start point: 3 axis move (3+2 only)	false
136	Output uncompensated preposition move before rotation	false
137	Output uncompensated preposition move after rotation	false
138	After rotation: home point suffix	"M130"
<b>MACHINE AXIS - XYZ</b>		
139	X axis prefix	"X"

These options are set false by default, so existing post processors will not be affected.

9392: Stock Models: The speed of Multi-Axis stock models calculation has been improved.

9393: Rest Finishing: A problem has been fixed where rest finishing against stock models could crash DEPOCAM.

9396: Coordinate System: There were examples which did not set Coordinate System correctly due to dividing by zero, this has now been fixed.

9399: User Interface: Drilling Cycle Dialog - There were occasions where the drilled hole image in the cycle dialog and plan label was not correct when Drill to Depth was set, this has now been fixed.

9401: Post processor: Heidenhain: Added the option 'Spindle speed variable comment' to allow a comment to be output after the spindle speed variable. By default, there is no comment, so any existing post will not be affected.

9402: Post processor: Heidenhain: Added the option 'Output the tool change for every toolpath' to allows the tool change to be output for every toolpath, even if it is the same tool number as the previous toolpath. The default is false so not to affect existing post processors.

9409: User Interface: Fixed an incorrect behaviour when selecting the focused tree view item when multiple tree view items are selected

9411: User Interface: Fixed an issue with the analysis dialogs remaining active after being closed.

9412: Linking: Fixed a problem which meant the start point could be lifted above the full clearance height.

9422: User Interface: Icons for turning passes and toolpath context menus have been improved and made consistent with the ribbon.

9423: Five-Axis: The advanced plan selection dialog was not filtering out deleted plans when creating the list of selectable inputs, this has now been fixed.



## Release Notes for DEPOCAM v19.0.04

19th July 2023

9018: Linking: Rest Finishing passes: When linking rest finishing passes, it was only possible to define vertical lead arcs. This can sometimes lead to entry and exit moves running along the surface, when the part has vertical walls. Now horizontal leads can also be defined. By default they are 0.

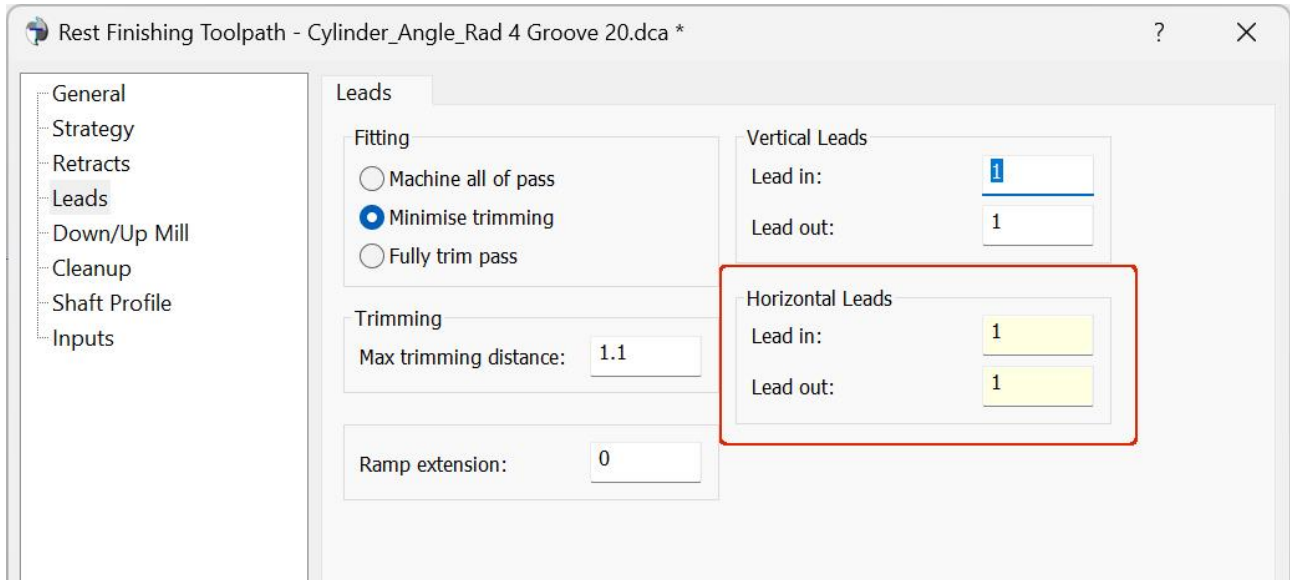

The image below shows a rest finishing toolpath. On the left only with vertical leads, on the right vertical and horizontal leads combined.

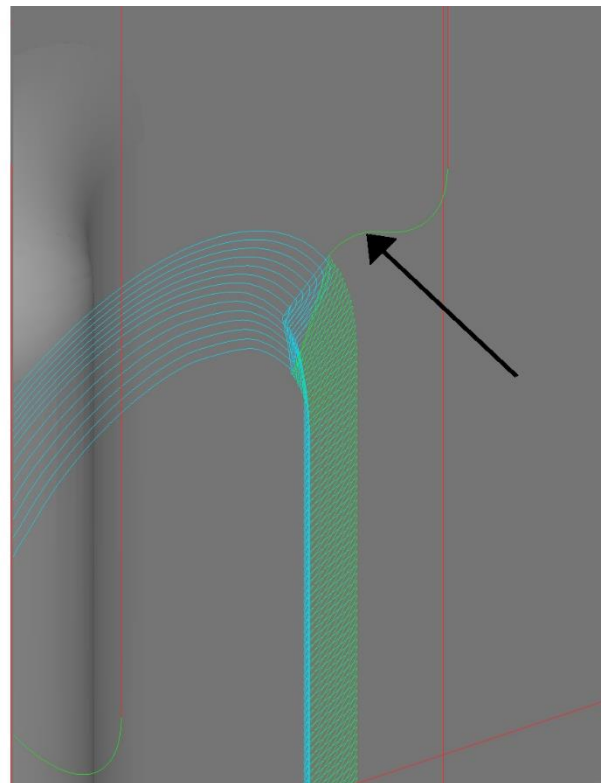
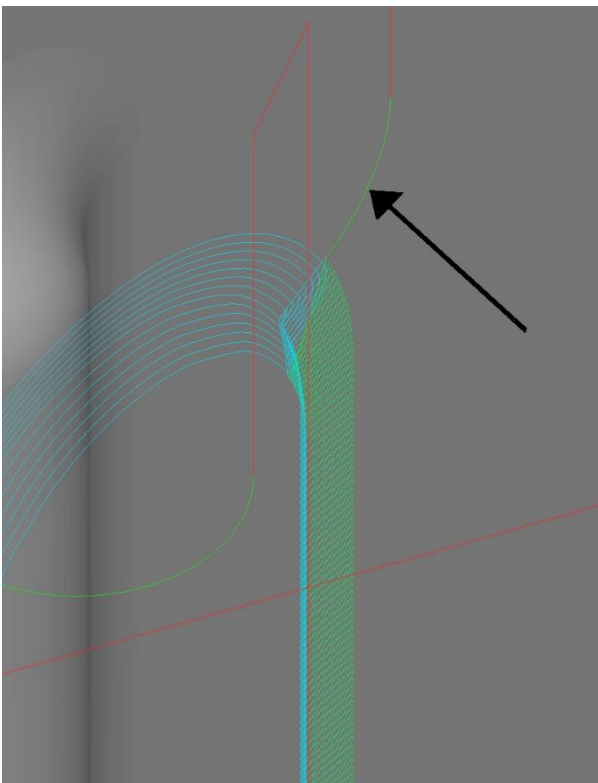

9020: ModuleWorks: In the ModuleWorks advanced dialog pages it is now possible to select the curves, drive and check surface folders directly in the advanced dialog. In the picture below, the second curve for a 5-axis morph milling is changed.

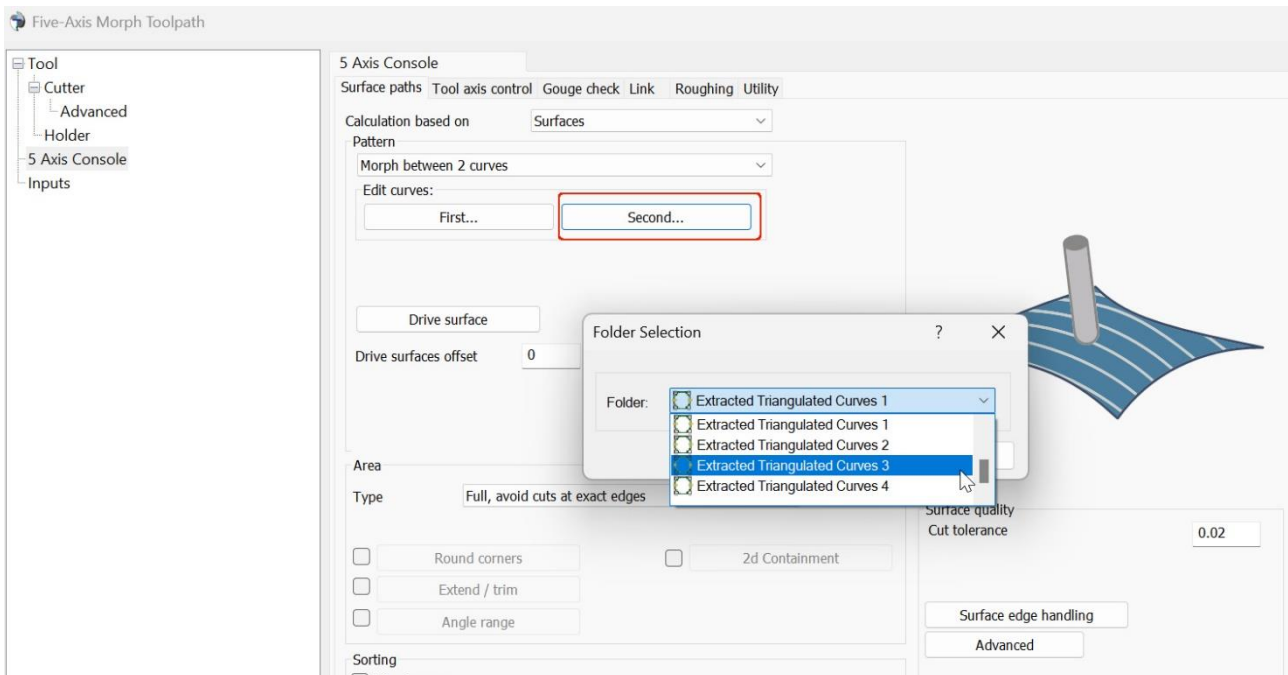





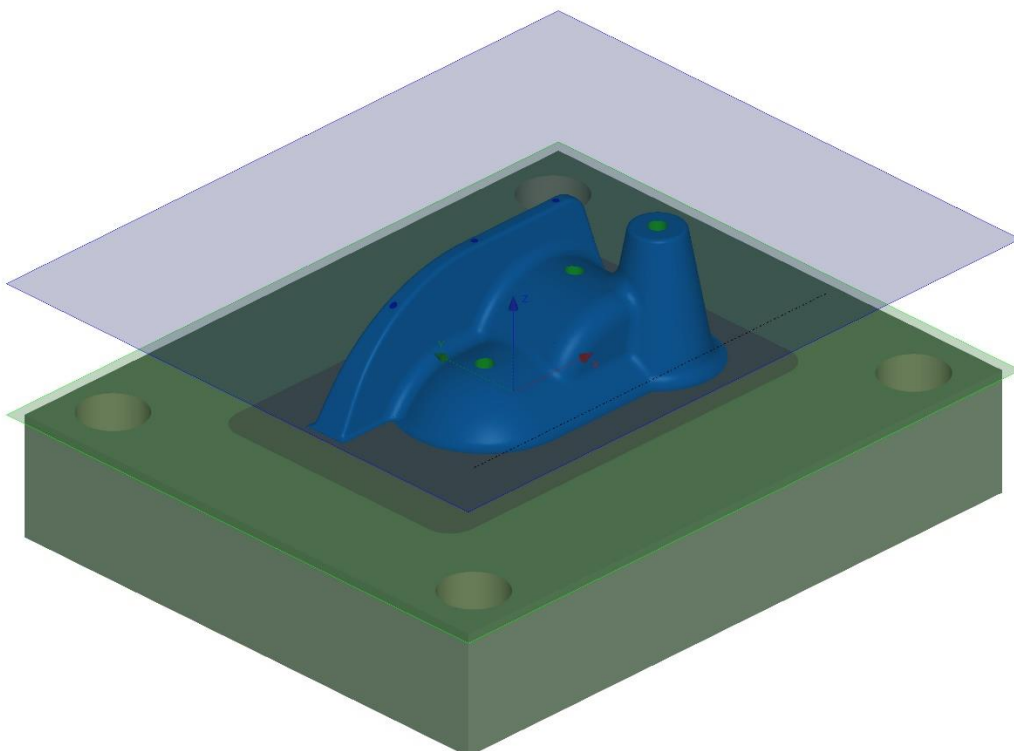

However, the appropriate folders in the tree view must still be selected in order to start the corresponding 5-axis strategy.

9092: UI: Z limit dialog guides have been added when passes are generated, to visualize the Limits Z max and min of the calculation.



9016: Import: We can now import Rhinoceros .3dm CAD files. As with the Catia and NX interface, this is an

additional purchase option.

 Part038_F.3dm	19/06/2023 13:06
 Part038.3dm	06/06/2023 10:08
 Part03802_Files	16/06/2023 16:29
 Part03801_Files	16/06/2023 16:26
 Part038_F10_Files	01/06/2023 14:33
 Part038_F09_Files	01/06/2023 14:32

Dateiname:

Dateityp:

Layer

- All Types (\*.dca;\*.msa;\*.igs;\*.ige;\*.iges;\*.stp;\*.step;\*.vda;\*.dtb;\*.ddb;\*.stl;\*.raw;\*.ttr;\*.tri;\*.dmt;\*.cld;\*.exp;\*.model;\*.mod;\*.dlv;\*.cat;\*.CATPart;\*.C
- Entity Archives (\*.dca;\*.msa)
- IGES Files (\*.igs;\*.ige;\*.iges)
- STEP Files (\*.stp;\*.step)
- Catia Files (\*.exp;\*.model;\*.mod;\*.dlv;\*.cat)
- Catia v5 Files (\*.CATPart;\*.CATProduct)
- Unigraphics NX Files (\*.prt)
- Parasolid Files (\*.x\_t;\*.x\_b;\*.p\_t;\*.p\_b)
- SolidWorks Files (\*.sldprt;\*.sldasm)
- Granite Files (\*.g.\*)
- ProE Files (\*.prt;\*.asm.\*)
- SAT Files (\*.sat)
- Rhino Files (\*.3dm)**
- Macro Files (\*.mco)

## We are pleased to release DEPOCAM version 19.0

These release notes cover the versions 19.0.0 to 19.0.03.

This is a major release so has several new and important features, the addition of turning is possibly the biggest feature. Another area where a lot of development work has gone into is improving the interaction with the software. That means the time it takes until a finished calculation is displayed, until something is selected in the graphic, until a dynamic graphic function starts, the time it takes to load a file etc. Other things like the ability to trim surfaces to a boundary will be useful too. There are many other smaller but equally important improvements as well as general fixes.

**Important:** One of the new features required a change to the tool database structure, if you use a saved tool database in v19.0 you will **not** then be able to use it again in v18.0.

We would strongly suggest you make a backup copy of your tool database(s) before proceeding with v19.0. Also due to the multiple changes to the database it is not possible to load v19.0 dca's into any previous versions of DEPOCAM.

### New features

6526: Turning: DEPOCAM now offers a Turning module.

#### Mini guide

With the introduction of turning, DEPOCAM now has two machining modes. The required machining mode needs to be selected in the quick access toolbar. It will default to milling when DEPOCAM is opened.

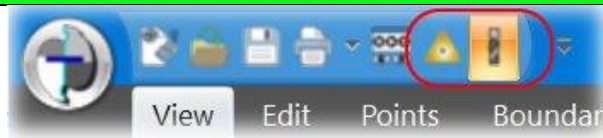

The Turning mode needs to be selected.

A triangular tip for Turning, and a slot-drill for Milling (shown selected in the image above). Selecting Turning will change the axis and some ribbon menus.

It is also possible to select the milling / Turning mode via the Application (file) menu > Mode > Milling / Turning.

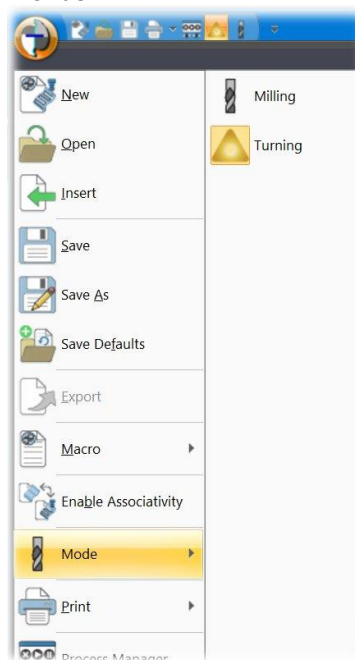

#### Note:

DEPOCAM will always open in the Milling mode.

The Milling mode axis and ribbon.

There is a **Milling** tab (in previously versions of DEPOCAM this was Passes).

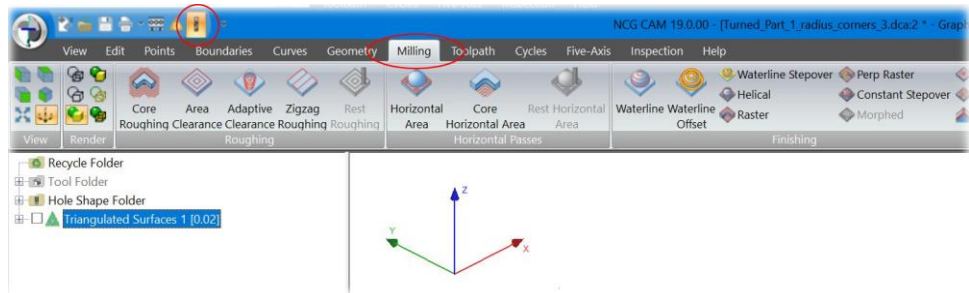

The Turning mode axis and ribbon.

There is a **Turning** tab. The Five axis menu is also hidden as it is only for milling. The axis only has a X and Y axis.

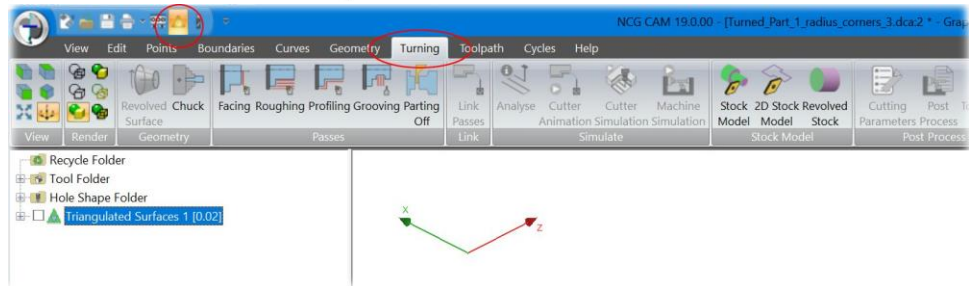

**Note:**

It is possible to have a database with both milling and turning operations.

If the Turning mode is selected, any milling operations will be greyed out, and erased from the screen if they were drawn. Any milling tools in the Tool Folder will be greyed out too.

Likewise, selecting the Milling mode will grey out all turning operations and tools.

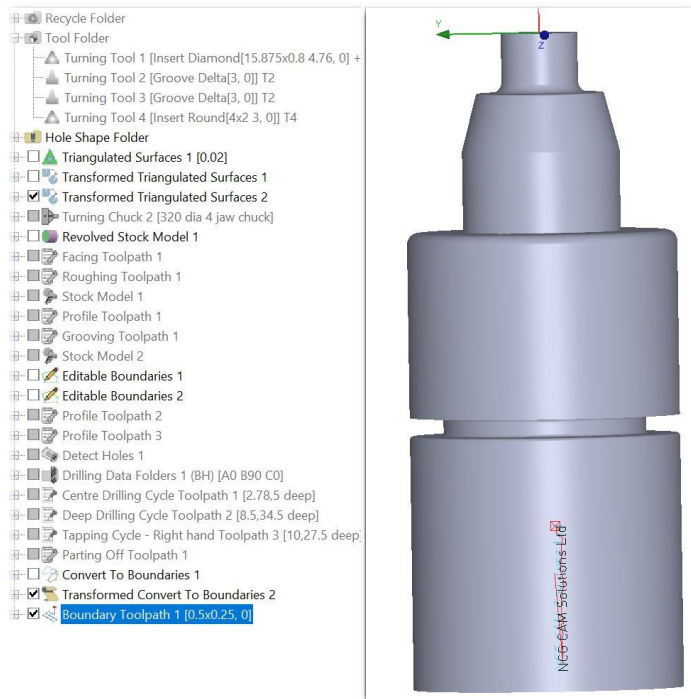

You may need to transform the part, just as you would in milling to align it with the axis and to have Z zero where you want it for machining.

*This model has some additional stock at the back (work holding end) – the part is 195 long.*

**Define the chuck:**

Optionally, a chuck can be defined, from the Turning ribbon.

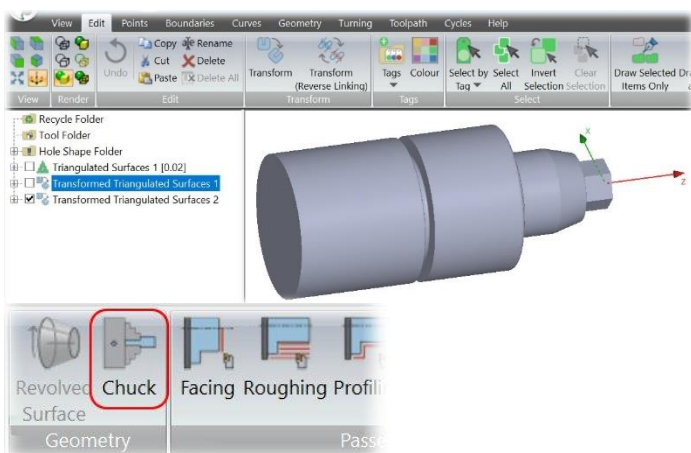

The easiest way to create the chuck is to use the Design button, and then draw a boundary for the chuck section.

*In much the same way as a tool holder can be created in the milling.*

Note: When defining the chuck, diameter values are used for the X axis.

It is a section that is needed, this is then revolved around the Z axis to get the 'full' chuck shape.

Once you have the required 'closed' section, use the 'Import to Tool definition' button.

Now you will see the 'full' chuck as a rendered form.

A Chuck margin can be set, so tools should not go past this plane.

The Chuck offset, allows the chuck to be translated along the Z axis. This allows the chuck to be positioned to suit different work pieces.

The chuck will appear in the tree as an item just like a set of triangulated surfaces or bounding box.

Optionally, a revolved stock can be defined.

Just like a triangulated surface, the colour can be changed and made translucent if you want.

Tools can be created in the Tools Folder prior to the passes.

*(Tools can be defined as the passes are created too, but for this example they are created in the Tools folder.)*

Note, the Centre Drill is a new tool shape so a centre drill can be defined now too.

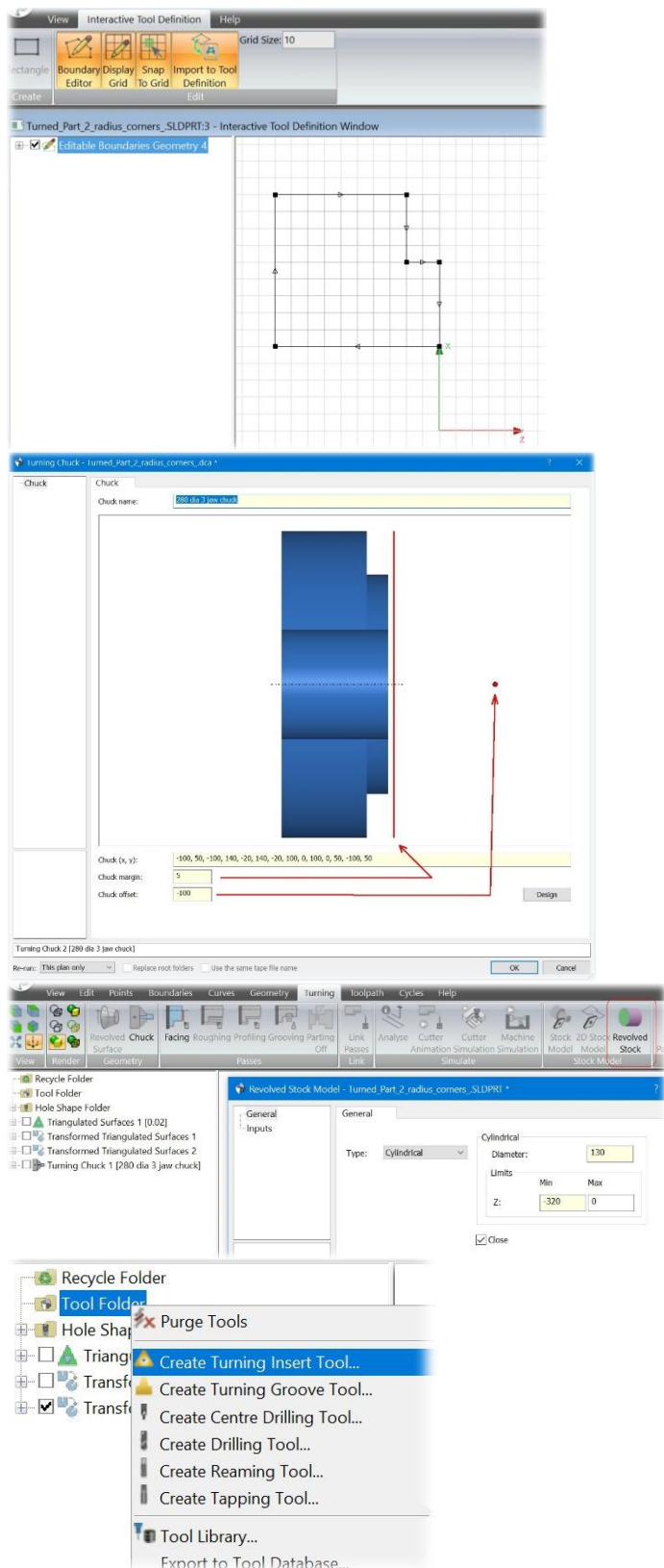

## Defining the Turning insert:

It is possible to set all the parameters manually if Custom is selected. But with ISO selected (ANSI if they units are set as inches), it is possible to pick the insert's ISO description / format by setting the required value from a drop-down list. That is the same on the Tool page as in the Insert page.

The Tool page also has options for the inserts angle and position (indicated by the red dot on the tip).

Inserts can also be defined in the Tool Database.

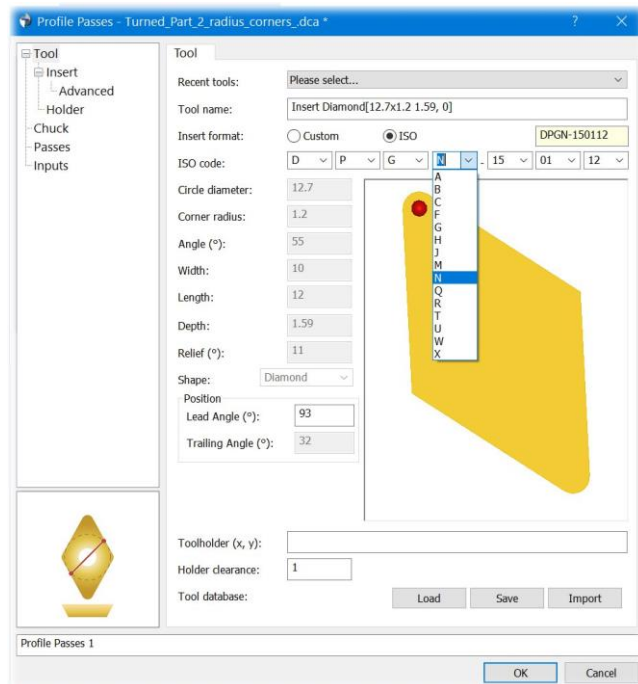

## Defining the Holder:

**NOTE:** This really is needed to ensure the back of the holder clears the part.

This is easiest done via the Holder 'Design' button. It is then possible to set a suitable grid size and click positions for the holder shape, the Holder requires a closed profile.

The default is for a Right-hand tool, but a left-hand tool can be defined. The Inverted option is normally ticked, this is for the tool to be at the back with the insert facing down.

The holder's Depth can be set in the Depth field, not so important for O/D turning, but for boring type operations it will be very important.

It would be best (quicker the next time) if the holder is also saved to a tool database.

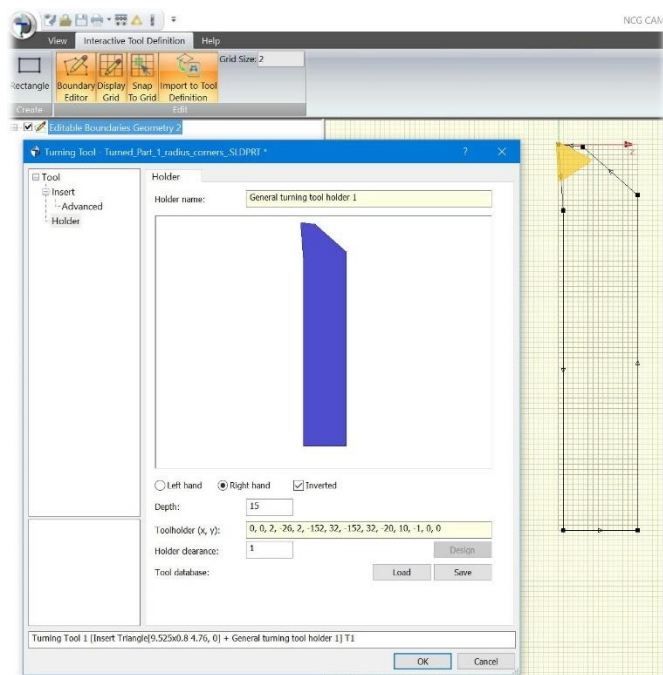

## Facing:

Select the parts Triangulated Surfaces and the Tool from the Tool Folder.

Select 'Facing' in the Turning ribbon

*Most or the tool parameters are greyed out in the image (right) because they were set in the Tool Folder.*

If you prefer not to define the tool first, the Insert and Holder details can be entered or loaded from the tool database.

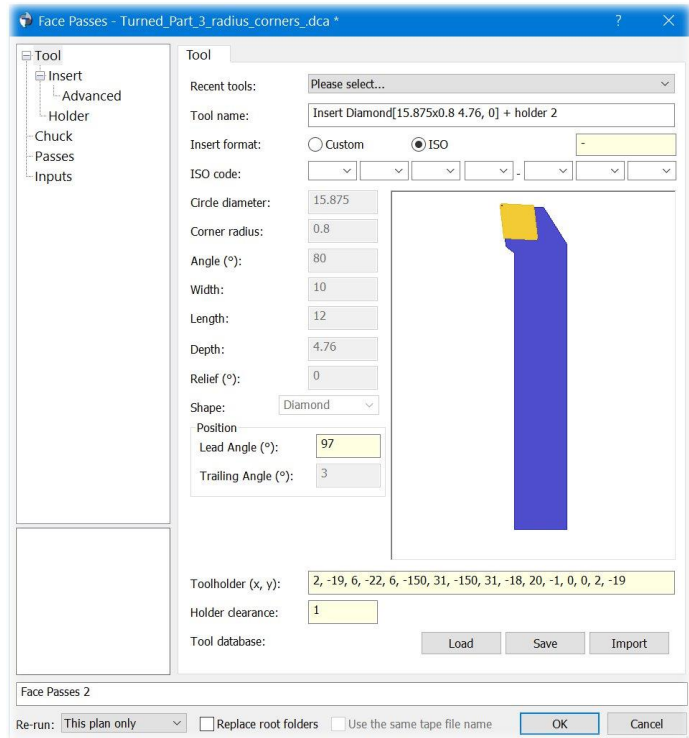

Click on the Passes page.

A thickness can be set to leave some material for a finish pass. The 'Number of passes' is set to 4, and a 'Stepover' of 1. Four passes will be taken to face the stock off to +0.2 of size.

In this example, the front of the part is 34.0 diameter, while the stock is 130.0 diameter, so the Pass extension – start' is used to extend the passes to outside the stock diameter.

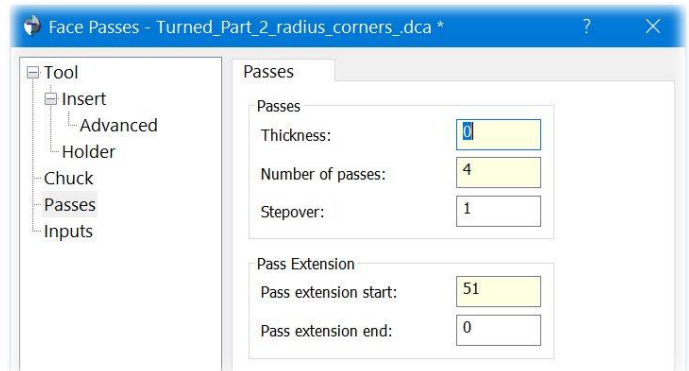

The passes then need to be linked.

On the General page, things like the clearance can be defined, the defaults are calculated from the part and passes (like the milling) so should be safe, the Clearance plane only option has been selected here.

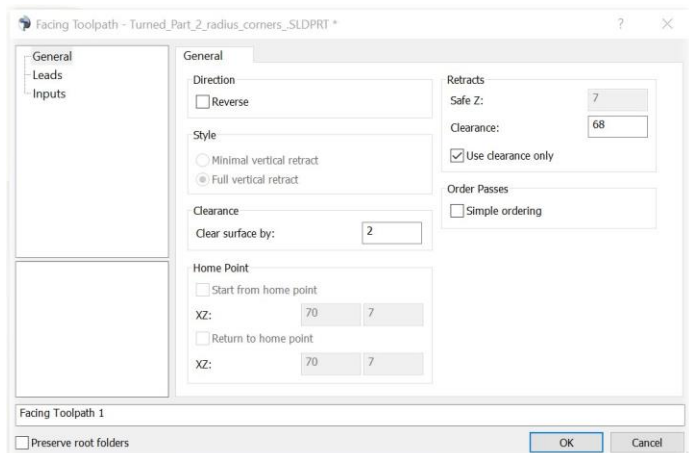

On the Leads page, ramp and lead in / out



extensions can be set, along with the lead angles.

Lead in/out arcs can be added too if preferred.

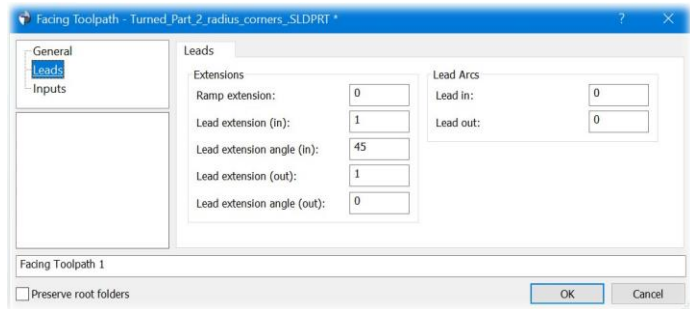

Turning toolpaths can be visualized with the Cutter Animated and Cutter Simulation.

As with the milling, the animation speed and position along the toolpath can be controlled with slider bars, it can be pause and stepped forward or backwards.

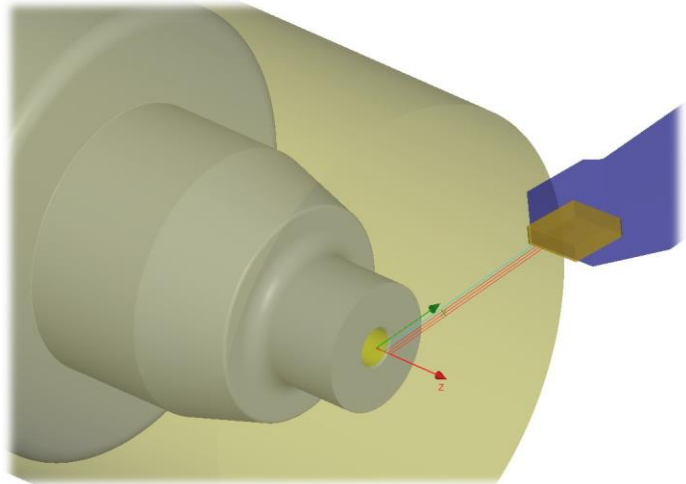

## Roughing out the form:

Select the required tool in the tool folder, and the surfaces folder in the tree. Optionally the chuck (if defined) can be selected too.

From the Turning ribbon, pick Roughing. On the Passes page, the Diameter and Z limits can be set to allow for stock or limit the turning range.

In the graphics window, the area to be turned will be shaded, the chuck will be shown and the guides for the Z Min / Max limits.

A thickness can be set to leave some material for a finish pass. The stepover (depth of cut) can be set too. The 'Direction' is the axis (X or Z) the stepover is made on. With Diameter set a pass will be made along the diameter, then make another pass along the diameter that is 2x the stepover smaller

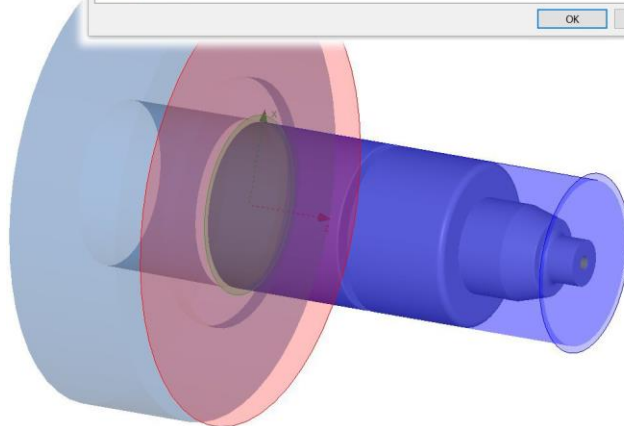
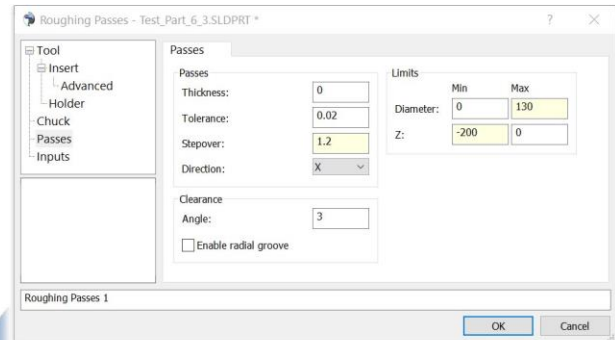

The passes need to be linked to create the toolpath.

*It is possible to select any 'unwanted' passes and delete them prior to linking if needed.*

The Toolpath can be seen in the image to the right. There are no passes can be seen that groove as the tool could not get in there.

Another reason for there being no passes in the groove is that the Enable radial groove option has not been enabled.

The Enable radial groove option (if enabled) allows areas that would be undercut when looking along the Z axis to be detected and considered for turning. The Clearance angle gives a minimum clearance as the tool turns in to the groove area.

*(It is also available in the profiling).*

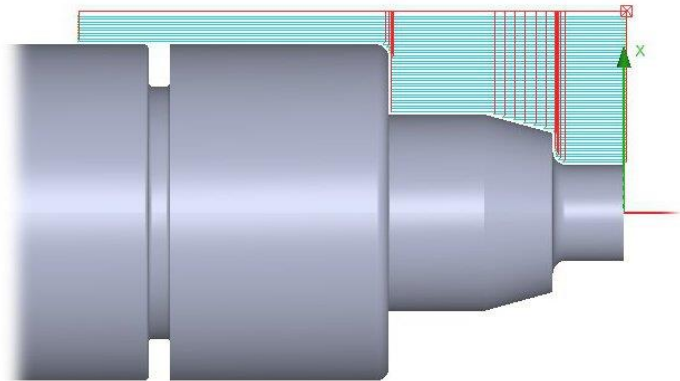

## Creating a stock model:

To see what it will look like; a stock model may be created. Select the toolpaths so far Facing and Roughing.

'Stock Model' can be selected in the turning ribbon. The dialog that is displayed is like the milling stock model, allowing the Z limits to be defined (the defaults will come from the selected toolpaths).

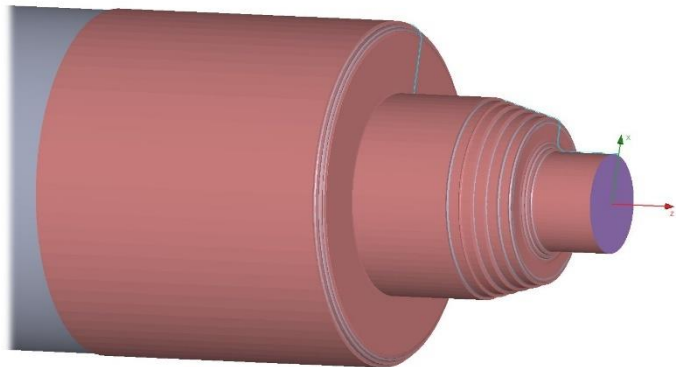
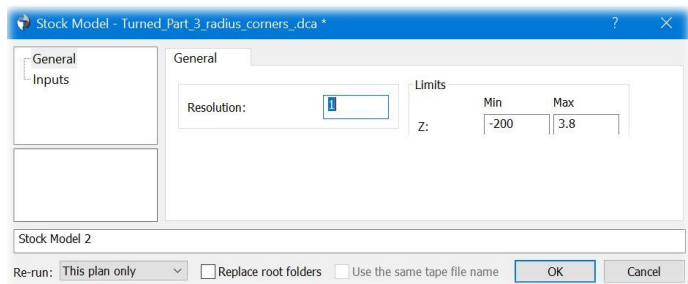

The resulting stock model.

## Profiling:

Select the part and optionally Tool and Chuck, then pick 'Profiling' from the ribbon. If a tool was selected the parameters will be greyed out, if no tool was selected then a tool will need to be selected from the Most Recent tools list, or entered manually

On the passes page, it is possible to define a thickness, a number of passes and a stepover. Here a stepover of 0.3 and 2 passes, so a pass will be made at +0.3, then another at size (as the thickness is 0).

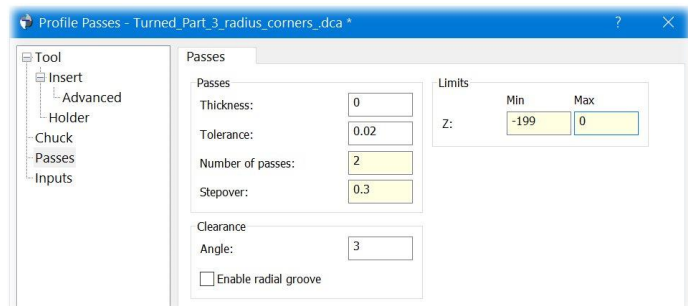

Just like the facing and roughing, the profiling passes need linking, on the leads page there are options to control the lead in and out moves.

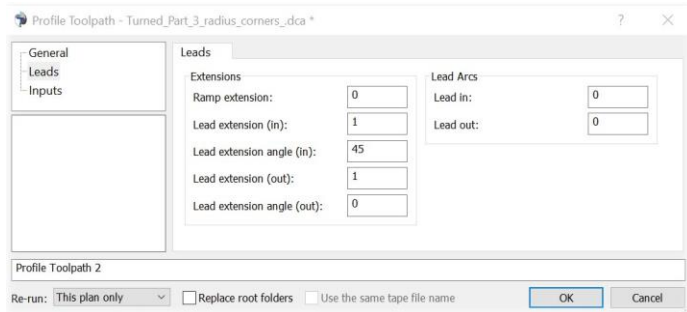

**Grooving:**

For this example, the grooving tool will be defined in the Tool Folder before creating any passes / toolpath.

Mouse right on the Tool Folder and select Grooving tool.

Assuming an indexable tip will be used, its possibly best selecting the Shape first, then go back and enter the widths and corner radii.

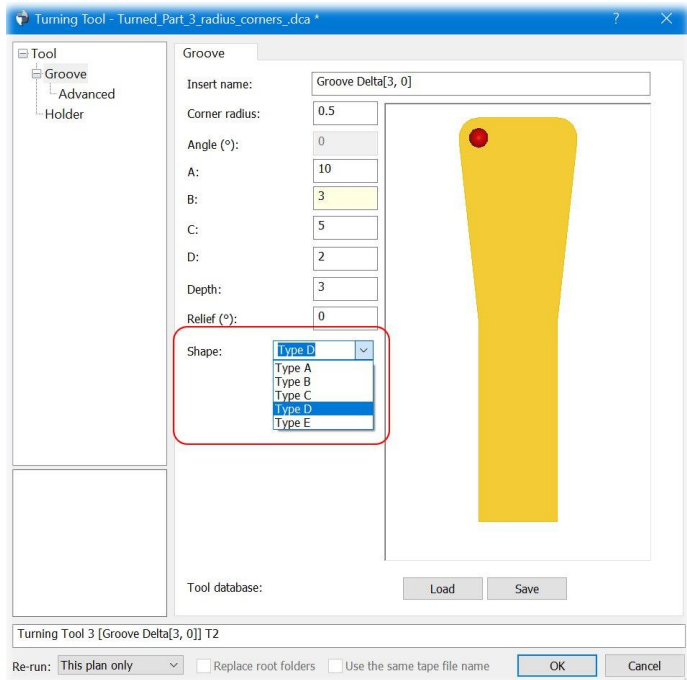

The tool holder can be 'drawn' quickly and easily in the Holder > Design.

Although having tips, holders and tools in a tool database is likely to be even quicker in the long run.

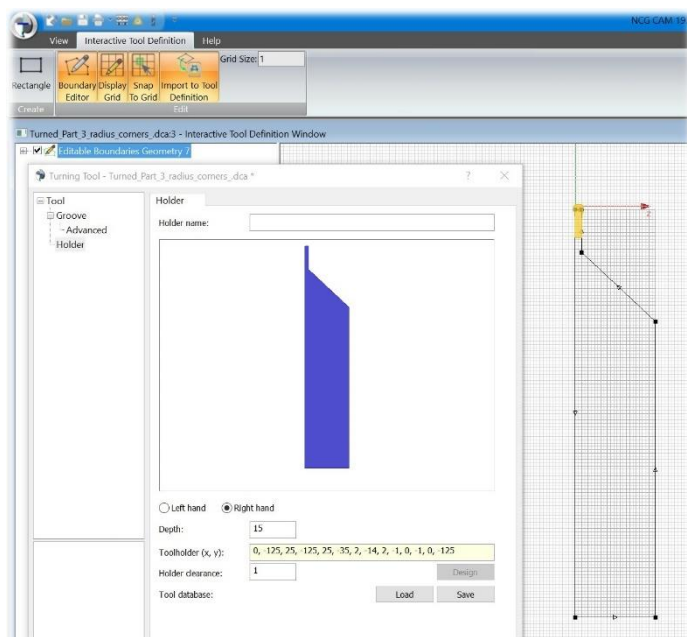

Select the part and optionally tool and chuck, then pick Grooving from the ribbon.

On the passes page, then Z min and Z max fields can be used to restrict the machining just to the groove. Rotating the part and clicking on the relevant surface is the quickest and easiest way to do that. A thickness can be added, so a finish pass can be taken later.

Either a Peck depth or Number of pecks can be selected, the peck depth is the default.

Using the Number of Peck depth option splits the distance from the X starting diameter to the part into the given number of pecks – if the bottom of the groove is conical, the cutting depth for each peck could vary across the width of the groove.

The peck depth option will maintain the cutting depth, but vary the number of pecks required if the bottom of the groove was conical.

After each peck it will by default back off by 0.1 (or used defined distance), or Dwell may be selected and movement of the X axis will stop for the given time (seconds or milliseconds – that will depend on the machine control).

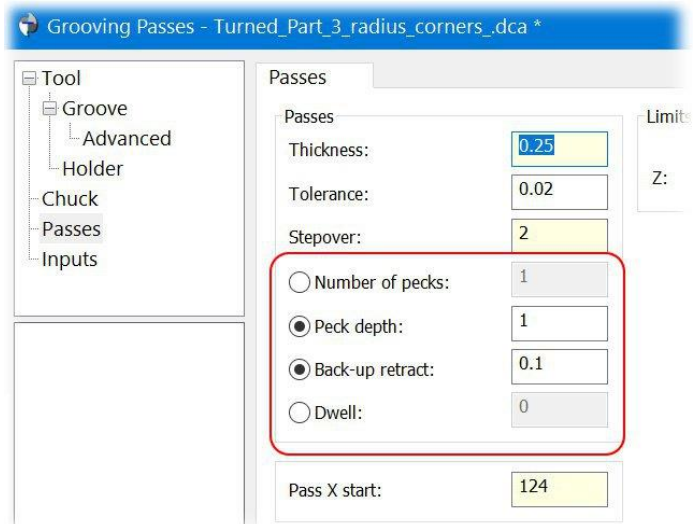
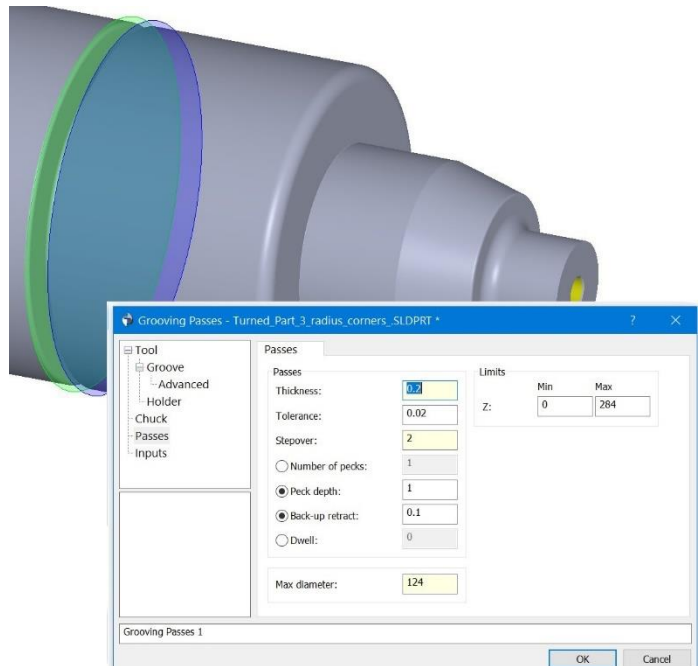

Passes can be deleted if needed.

In the image to the right there are some grooving passes that do not go into the groove. (These are because of the insert width and the Z limits).

Select those, and press delete.

Linking the grooving is the same as linking the profiling.

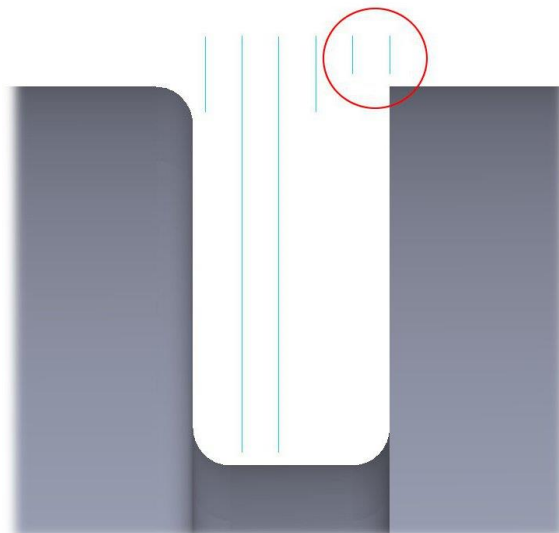

### Profiling the groove:

The groove has been roughed out, but there will still be some stock from the thickness that was left, and because of stepovers and pecks.

To finish this form a round Insert will be used, being defined in the Tool Folder first.

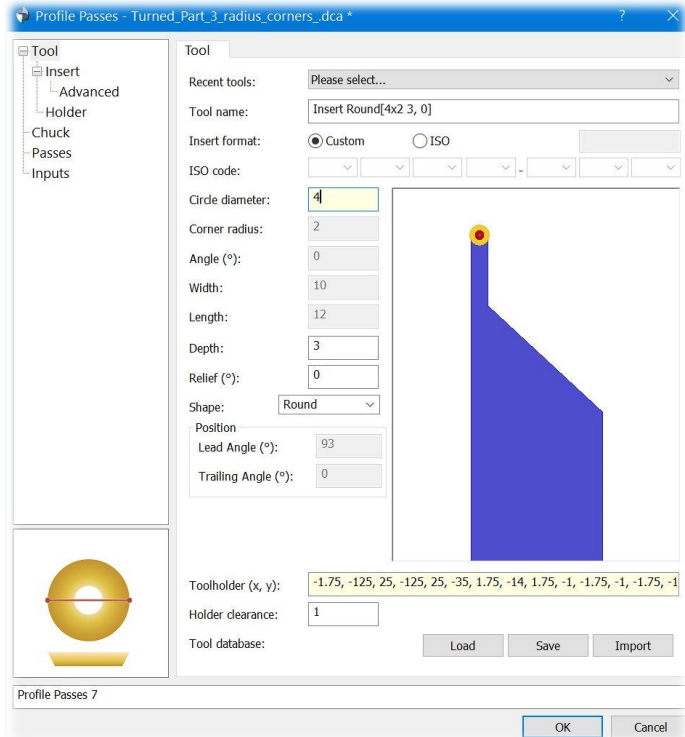

To constrain the passes to just one side of the groove, boundaries will be used, they can just be rectangles – one for either side of the groove.

Each boundary is in its own folder, but they have been created to overlap slightly in the groove.

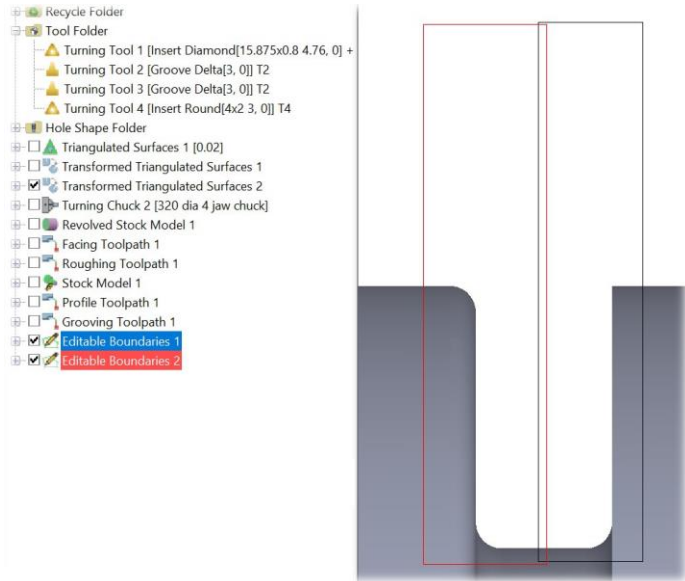

With the Tool, Triangulated Surfaces, Chuck, and the right-hand boundary folder selected, pick profiling. On the passes page, the number of passes has been set to 2, and a stepover of 0.12

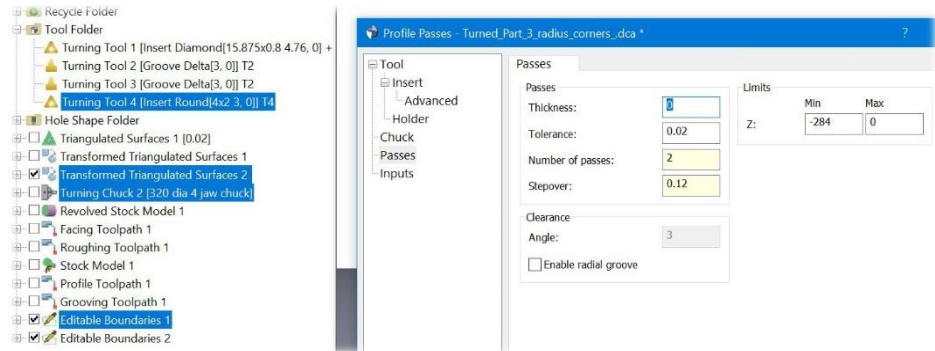

Those passes can then be linked, in the same manner as the main form

was profiled was linked. With the Tool, Triangulated Surfaces, Chuck, and left-hand boundary folder selected, pick profiling. On the passes page, the number of passes has been set to 2, and a stepover of 0.12

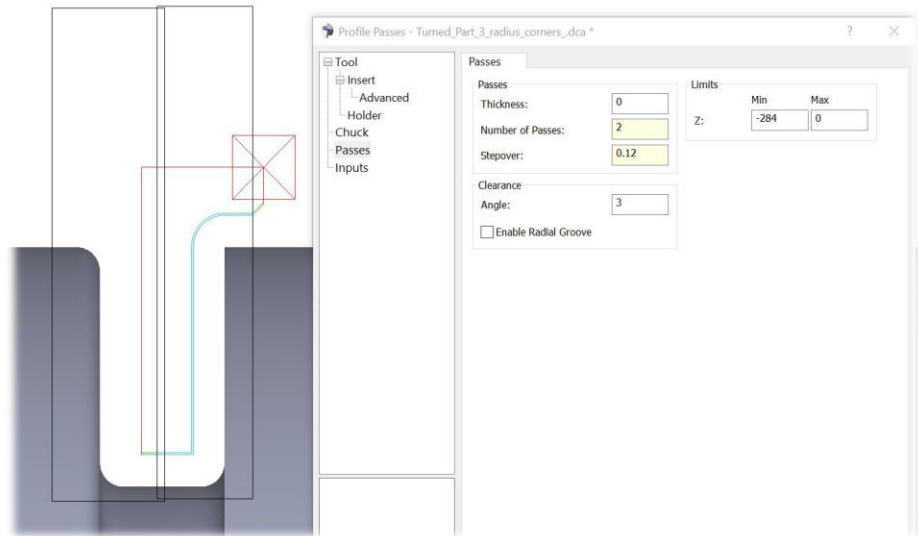

*Note: The previous profile toolpath can be seen here for the right-hand side of the groove.*

When linking the passes for the left-hand side of the groove, the Direction needs to be reversed. This will make the cut start on the O/D and move away from the chuck and into the groove.

*If the reverse is not set, it will start at the bottom of the groove, and pull out and move towards the chuck.*

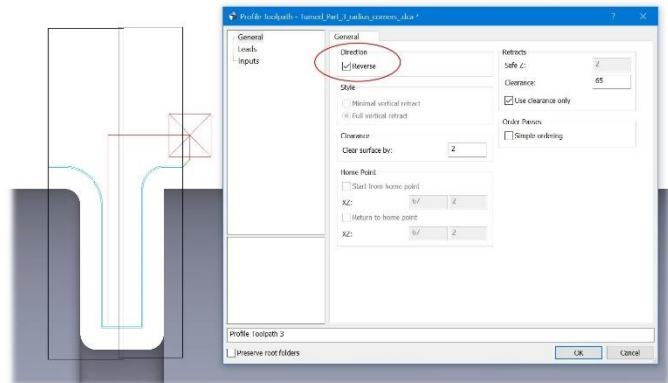

## Drilling (on the Centre Line):

This part has a M10 hole in the centre that can be drilled and tapped. With the Triangulated Surfaces selected, mouse right and pick 'Detect Centre Line Holes'.

Or the 'Detect Holes' option can be used in the Cycles ribbon.

Because the hole must be on the Z axis, a lot of the filters are greyed out.

Then the drilling data folder can be created.

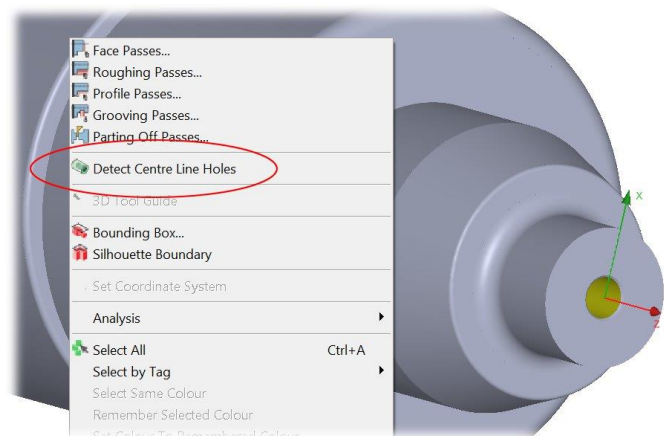

Expand the Drilling Data folder and select the hole, then from the Cycles ribbon or mouse right menu, pick Centre drill.

The centre drill size can be selected from a list, and it will update all the relevant fields.

On the passes page you may want to adjust the depth or, set a dwell time.

Then link the Centre Drilling cycle.

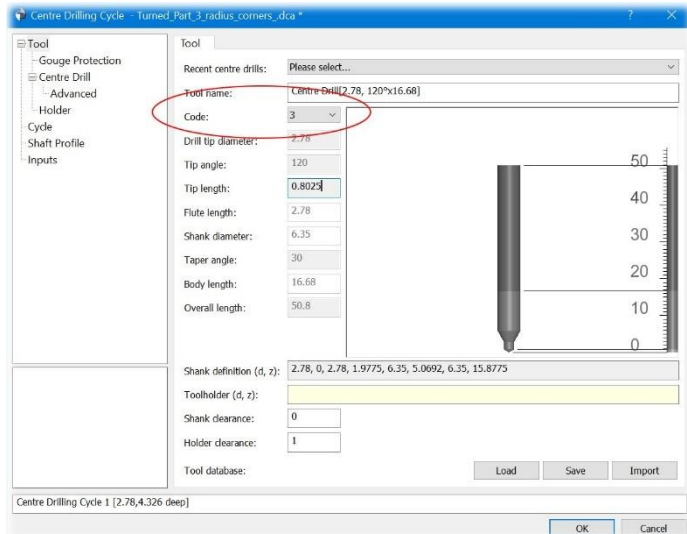

Deep Drilling the hole is basically the same as Centre Drilling, select the hole in the Drilling Data folder, mouse right and pick 'Deep Drilling', define an 8.5 drill, and then on the Cycle page, set the Peck Depth, and Chip Break if needed.

Then link the Deep Drilling

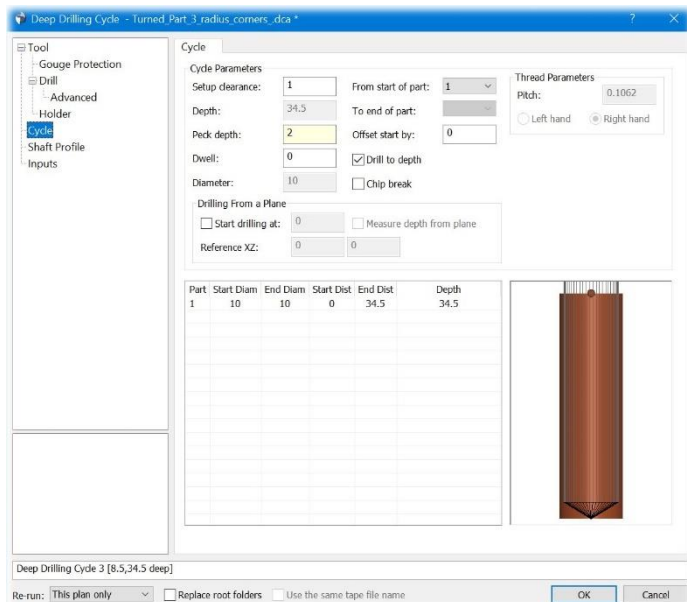

Tapping is the same again, just a different cycle, the Pitch will need setting, and ensure to stop short of the bottom of the hole.

If you have created a compound cycle for this type of hole, that could be used also.

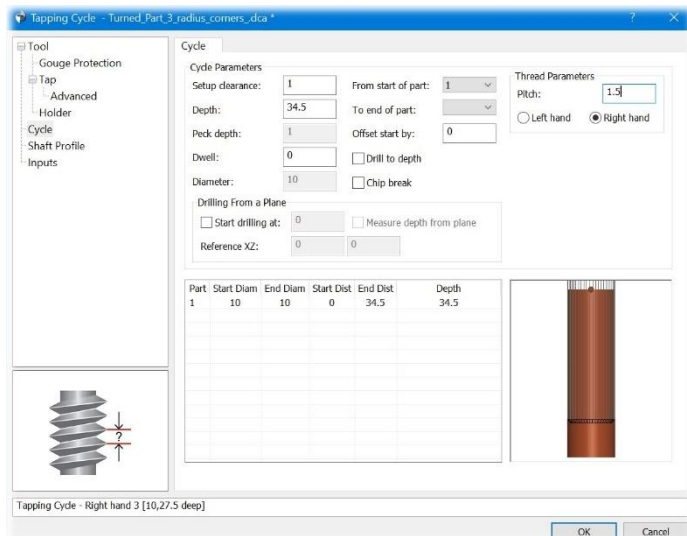

### Parting off:

Parting off is very similar to the grooving, the main difference being the parting off position, there is a DZ point, from when the parting off is to start.

For this example, the part is 120 diameter, so X will default to 60, and Z has been set to -195

For the Pass Extension, 3 has been set, so the pass starts 3mm before the part, and the end set to -1.5; setting -1.5 will force the pass to stop 1.5mm short, so the part remains attached to the stock by a 3mm diameter pip.

The parting off does not respect the surfaces, you can part off through the model.

The linking is the same as grooving.

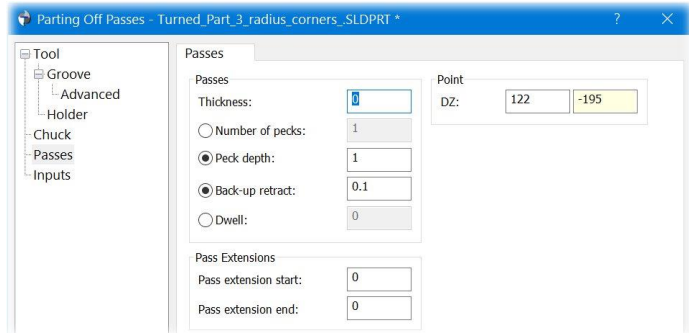

### Cutting parameters:

For the Facing, Roughing, and Profiling, the same tool was used, so all three can be selected in the Operations tree, then click, mouse right > Cutting parameters. Set the tool number, and coolant.

For the Spindle Speed there are two options, 'Use constant cutting speed' (the default), and a cutting speed in m/min. If that option is un-ticked, it will be a constant Spindle Speed and the RPM can be set.

There are two methods of defining the Feedrate too. It can be as feed per rev, or distance per minute. That is controlled by the 'Use feed per revolution' check box.

Other tools are set in the same manner, but clearly the tool number, and other cutting parameter will need to change.

The canned cycles use RPM for the spindle speed, and mm/min for feedrates.

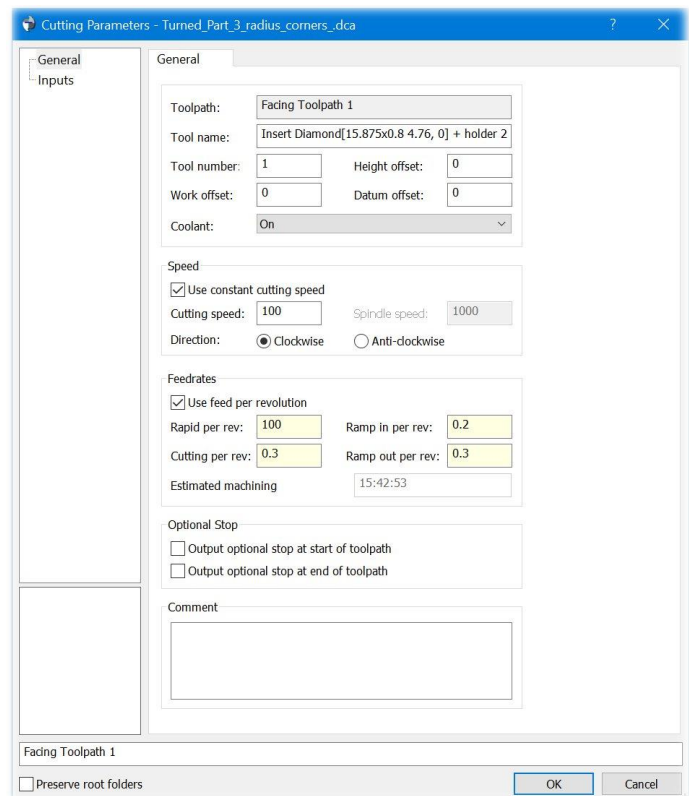



## Post processing.

Select the toolpaths in the order you want to post then and pick Post Process from the turning ribbon. Then select the post (only turning post will be displayed, in the milling mode only milling posts are displayed).

The order and tool numbers can be checked on the Toolpaths page.

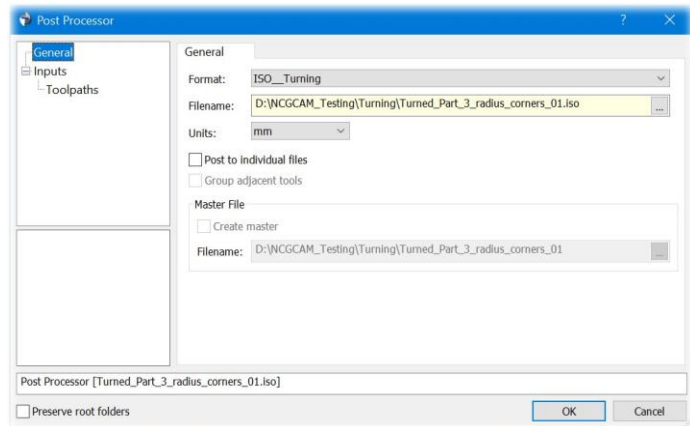

4813: It is now possible to trim the surfaces to a given boundary, with options to keep the interior or exterior. Also fixes Tickets 8105 and 8106.

### Mini guide:

You need a single boundary to trim too, that boundary could be imported, extracted from a surface, or drawn manually. Boundary folders with rotations are also permitted.

Select the boundary folder. Triangulated surfaces folder and the surface to be trimmed.

**Note:** If you do not select individual surfaces, all surfaces will be considered for trimming. But if individual surfaces are also selected, only they will be trimmed.

From the Geometry ribbon, click Trim Surfaces with Boundaries

That will display a dialog, offering the option to keep the interior or exterior part of the surface being trimmed.

Click OK.

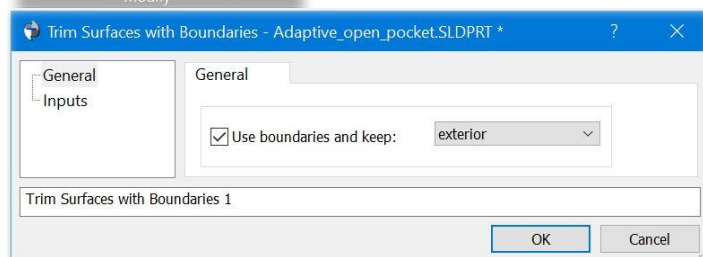
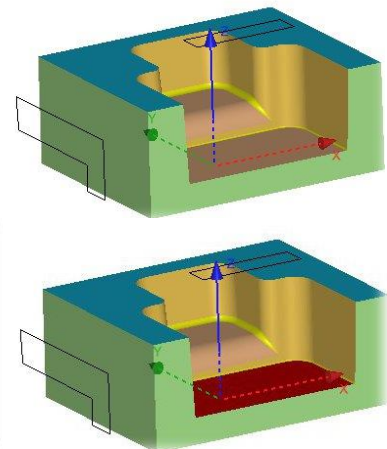
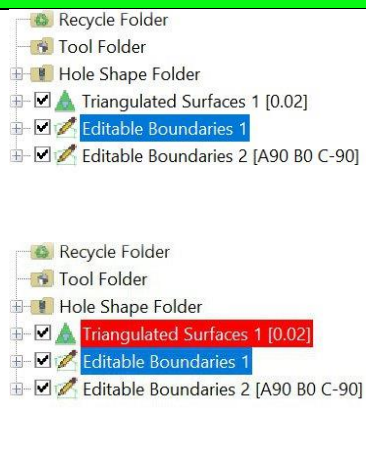

Here the result of having trimmed two individual surfaces, keeping the exterior in both cases.

- Recycle Folder
- Tool Folder
- Hole Shape Folder
- Editable Boundaries 1
- Editable Boundaries 2 [A90 B0 C-90]
- Edited Triangulated Surfaces 9

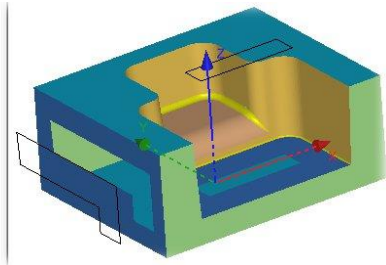

- Tip:** If the Ctrl key is pressed when clicking on Trim Surfaces with Boundaries, a new Triangulated Surfaces folder will be created.
- Note:** If an External Trim Surface is applied prior to trimming surface with boundary, the surface trimming will be based on the output of External Trim Surface. No result will be created if the Untrim Surfaces is applied prior to trimming surface with boundary.

## Key enhancement

8137 and 8858: Toolsheets: The views of three- and four-view image layouts can now be individually configured. This required the User Interface for the Toolsheets bitmap writer and images dialog to be rearranged grouping relevant options together. Also updated the documentation.

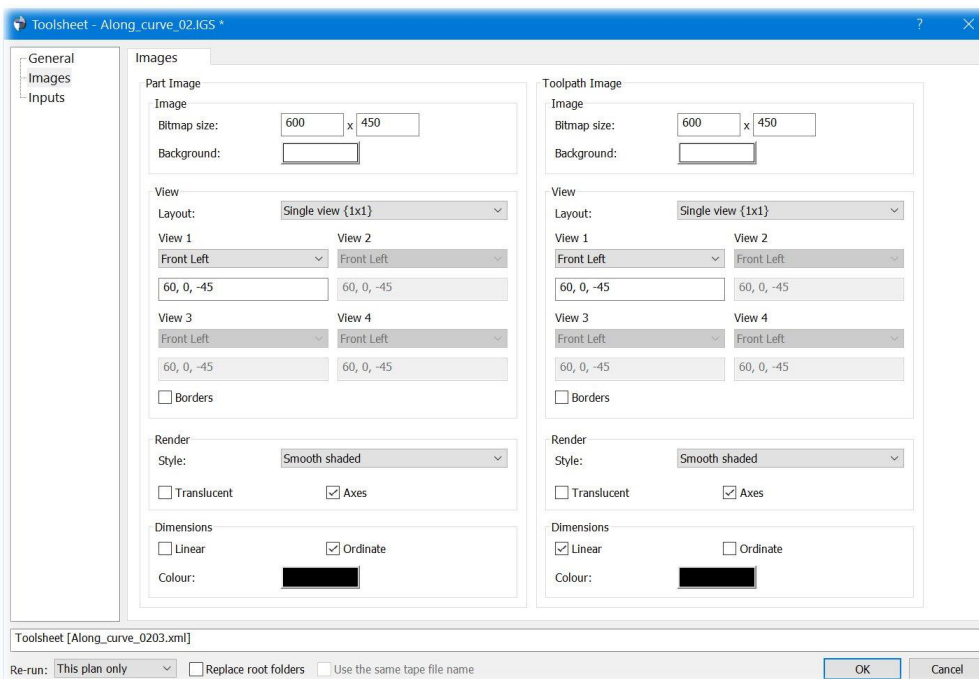

8546: Boundaries: Improvements have been made to the quality of shallow area and cutter contact boundaries. Curvature analysis has been improved by better use of parametric surface data.

The images below show the shallow area boundaries over the surfaces, using a 10x1 cutter, using the angles 0° - 30° at 0.02 tolerance.

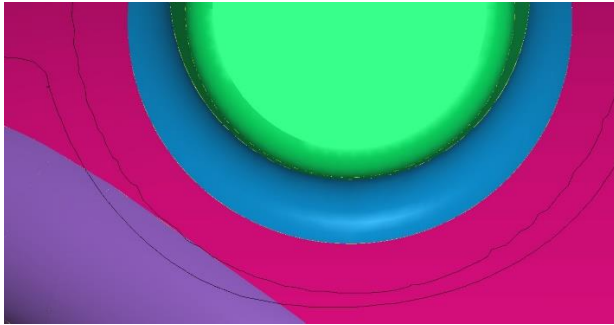

v18.0

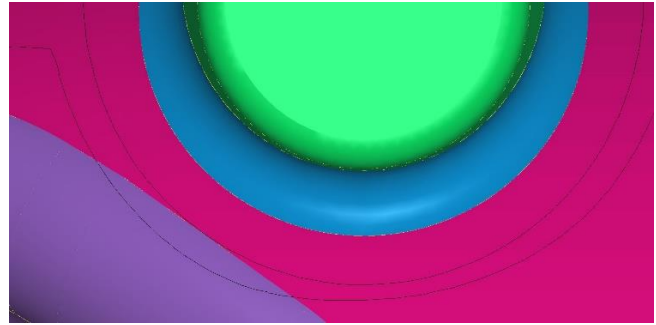

V19.0.01

The surfaces have been removed in the following images for clarity.

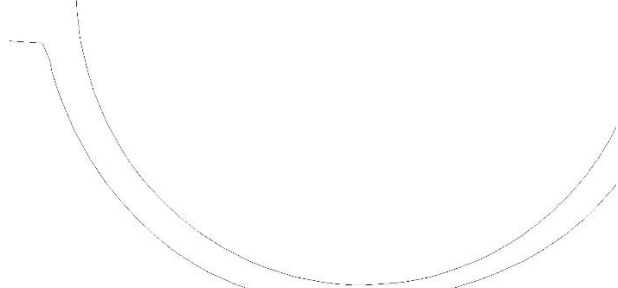
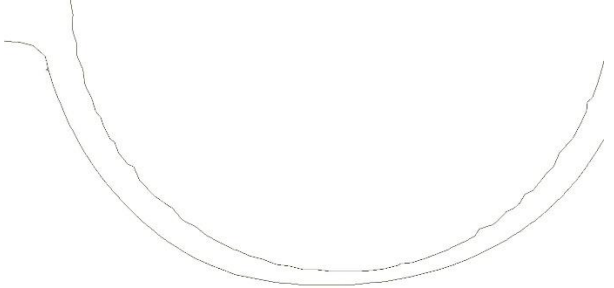

While visually looking better, this is extremely helpful when the passes need to follow the boundary, for example constant surface stepover.

8860 and 8733: Toolsheets: Ordinate dimensions can now be drawn on the toolsheet images.

Cutter diameter		Corner radius		Boundary Toolpath 1 [20x3.5, 0]				17 April 2023	
20		3.5							
Tool name		Toroidal[20x3.5 40, 0]							
Cutter name		Toroidal[20x3.5 40, 0]							
Tool holder name		Not available							
Tool type		Toroidal							
Tool number		1							
Strategy		Boundary							
Body length		40							
Taper angle		0							
Thickness		0							
Tolerance		0.02							
Z clearance		129							
Step over		0							
Step down		0							
Spindle		2387							
Coolant		Off							
Rapid		10000							
Ramp down		895							
Cutting		1193							
Ramp up		1193							
Shaft profile									
Required body length		Not available							
Required cylindrical length		Not available							
Home Point		X	Y	Z					
Start		4.771	-33	129					
End		4.771	-33	129					
Workplane		A:0 B:0 C:0		Work offset		Not available			
Motion		Min	Max	Tapefile		D:\NCGCAM_Testing\kidney_tray01.apr			
X		-71.561	4.771	Project directory		D:\NCGCAM_Testing\			
Y		-16.493	-20.444	Project comment					
Z		124	129	Toolpath comment					

Note: the dimensions can only be shown on views along the XYZ axis, dimensions will be omitted on any rotated view.

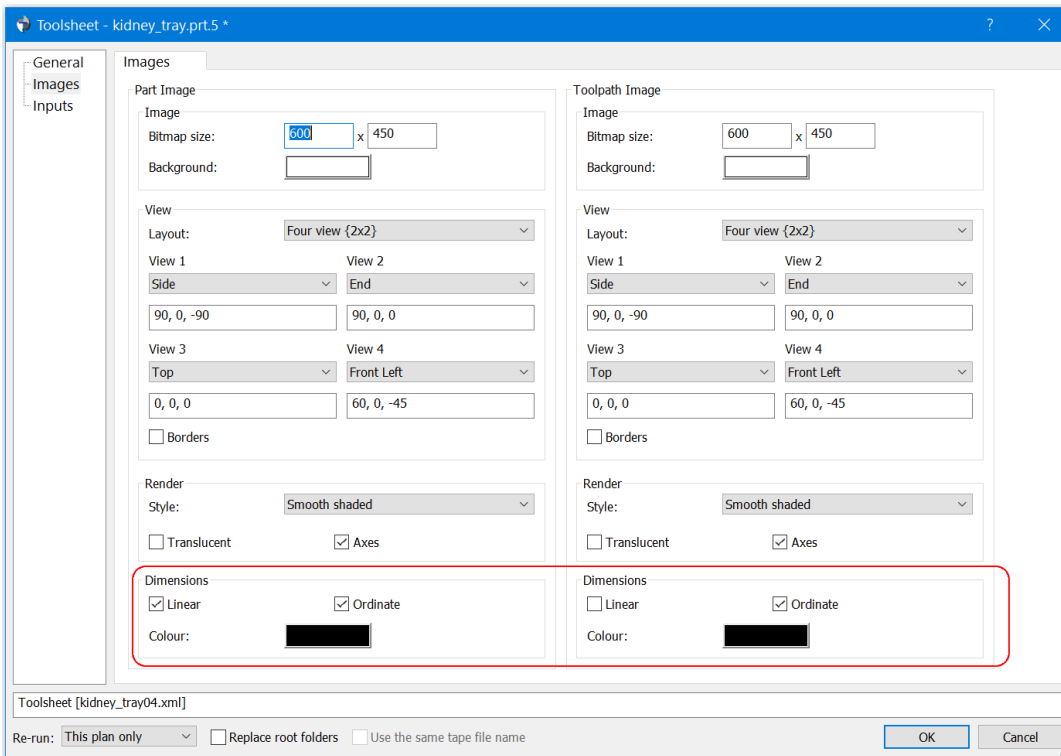

The options are on the image page of the toolsheet dialogs with options for linear and ordinate style dimensions, there is also the ability to change the colour of the dimension arrows.

## General

2854: Import: Loading geometry files is now much faster due to using multi-threading which allows the triangulation of surfaces to be performed in parallel.

3137: User Interface: We now display a minimum of 3 decimal places for coordinates displayed in the status bar.

id 100% X 14.226 Y -23.322 Z 25.000

3720: Drilling. The shank definition for drilling tools (except centre drills) now may be modified in a similar manner to milling cutters. Also fixes tickets 6104 and 7672. This will be very useful for micro drills and drills that have a Morse Taper shank, as with the milling, the shank is gouge protected.

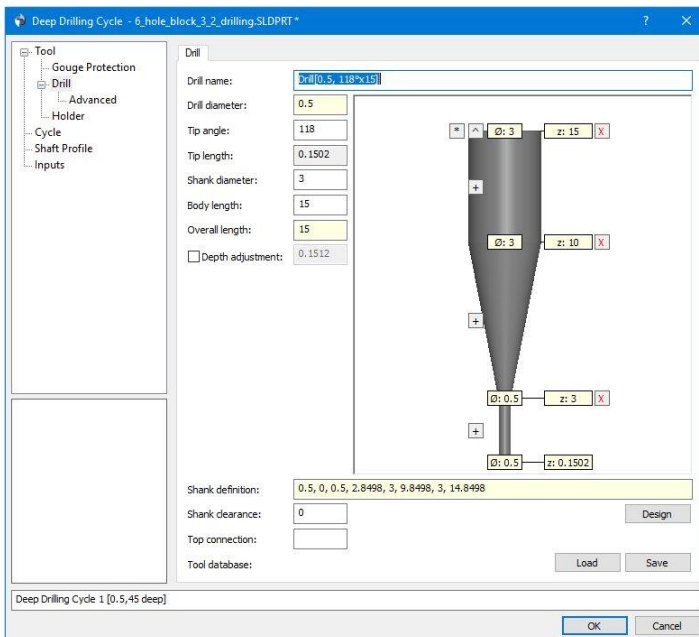

4148: Rest Waterline Passes: The quality and consistency of integrated rest passes has been improved, this should give a better smoother appearance to the end of the passes.

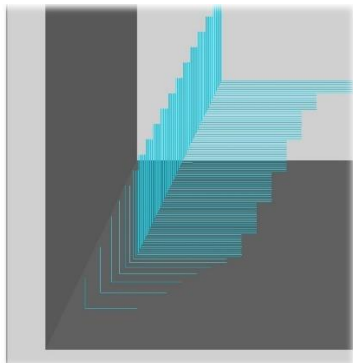
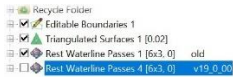

Before, the end of the passes would appear to be 'stepped',

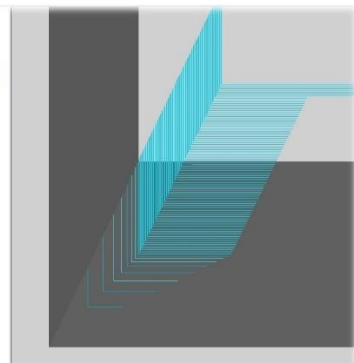

In v19.0.00 this is now much smoother and should give better results.

4567: Toolsheets: Part and toolpath images now use the available space more efficiently resulting in a larger image.

5149: Fixed an issue where some databases saved with running plans were not reloading correctly.

5283: Boundaries: When using properties to modify an editable boundaries plan we now copy the boundary collection into a new editable boundaries plan.

5427: Reduced database load times. Also fixes Ticket 6598.

5837: When the 'Program Data Folder' (specified in Options > Defaults) does not exist, the DEPOCAM now uses the default folder (C:\ProgramData\DEPOCAM Solutions) instead. If this happens, a warning dialog box is also shown.

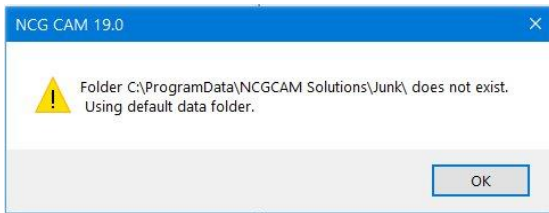

6049: Rest Roughing: The Overthickness should now always be calculated as negative value by default.

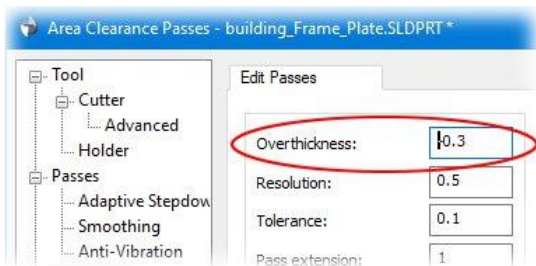

6117: Export: The VRML option now supports Barrel cutters.

6418: Detect Holes: Added the 'Min' and 'Max' angle to the filter page. The angle range is active when filtering by supplied A,B,C axes.

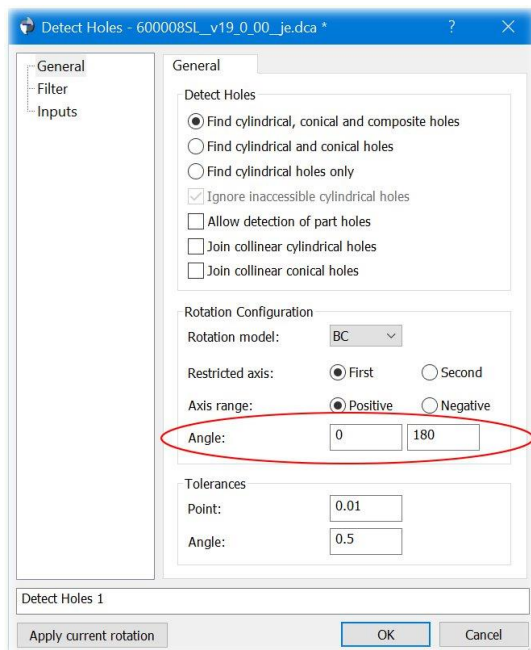

This could in some cases help when selecting holes by avoiding unwanted holes. The restricted axis must fall within the Angle range.

6864: Spiral Passes: The quality of spiral passes on examples machined to tighter tolerances has been improved.

7094: Datums: We can now set and switch coordinate systems on several selected triangulated surfaces, triangulated curves,, and triangulated points folders, this is possibly most useful when loading a part and using the 'Load component information' option.

In use, create the required 'Coordinate system', expand the folders so any triangulated surfaces, triangulated curves, and triangulated points folders can be selected, select the required 'Coordinate system' too, then 'Set coordinate system' may be picked.

7146: User Interface: Added "Organise by Layer" and "Load Component Information" options to the 'Preferences' page in the Options dialog.

See ticket 7715 for a screen-shot of the dialog.

7206: Selected Surface Waterline Passes: A problem has been fixed, for cases where small gaps could appear in selected surface waterline passes. This also fixes tickets 7993 and 5607.

7559: User Interface: The toolpath naming has been changed so when linking with Protect Surfaces (Linking Clamp surfaces) the new plan isn't labelled as a rest toolpath.

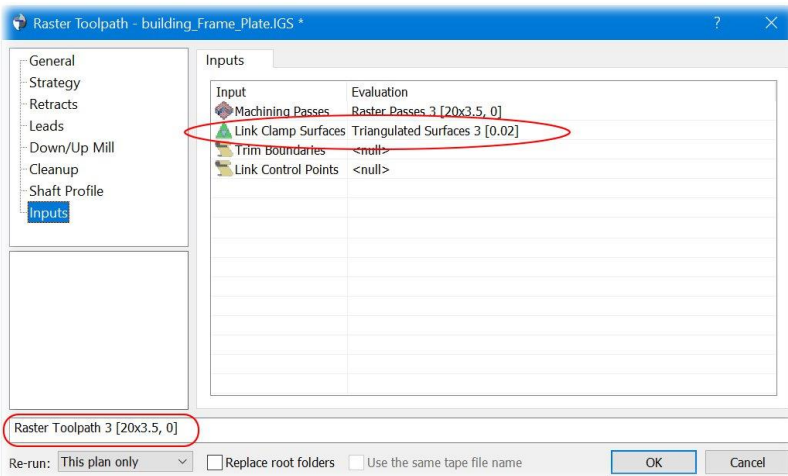

7715: Import: IGES files loading through the Convert to NURB option now have an option to use 3D trimming curves. This 'Prefer 3D trimming for IGES file loaded with the Convert to NURB can be set in Options > Preferences > Open File.

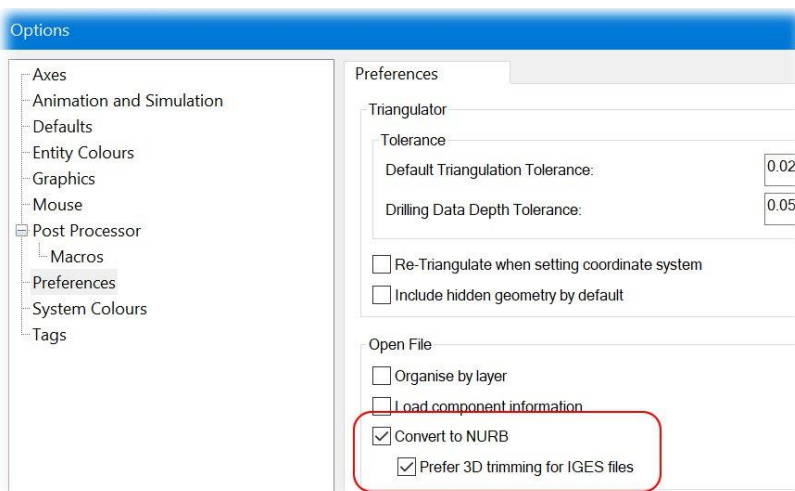

They are shown ticked here but are unticked by default.

7836: Waterline Passes: The contact angle checks have been tightened. Previously it was possible to get

passes on surfaces where the contact angle could be as much as one degree outside the selected range.

7857: User Interface: Fixed an issue when closing a database causing the program to exit, Close should close the database, but keep DEPOCAM running, Exit should close the database and close DEPOCAM.

7874: Thicknesses: The "Thickness Definitions" page of the raster reference manual has been updated to improve the description of how unequal XY and Z thicknesses are applied. In addition, error messages for invalid combinations of thicknesses have been improved.

This can allow for a wider difference between the XY and Z thicknesses, as a shift can now be made on the tool axis. For example, in v18.0 a 0 XY thickness and 10 Z thickness would not be permitted, in v19.0 it is valid. It may still require the 'OversizedNegativeThickness.vbs' script to be run first, which can be found in the DEPOCAM install folder (usually C:\Program Files\DEPOCAM 19.0), but once run for v19.0, it's done. There are some limitations as the calculation cutter cannot be negative. Also fixes ticket 8145.

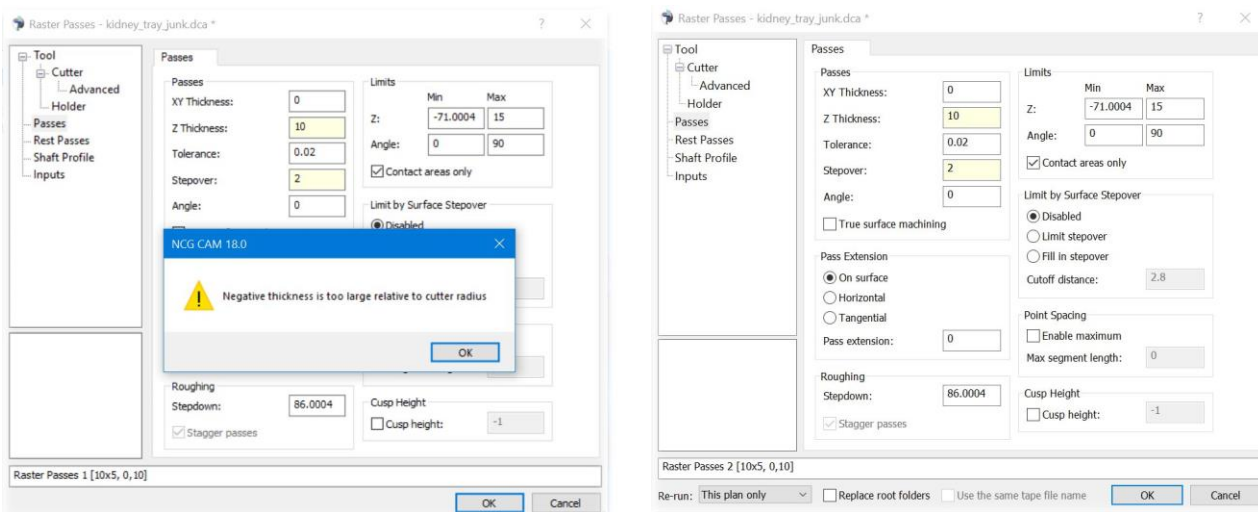

V18.0 - Thickness: XY = 0 Z = 10 triggers a pop-up message, and will not allow those thicknesses. V19.00 - Thickness: XY = 0 Z = 10 is permitted.

7884: Selected Surface Waterline: A problem has been fixed where use of the Smoothing option could result in excess Selected Surface Waterline passes.

7886: Compound Cycles: We now preserve over-riden plan labels when loading and running saved compound cycles.

7892: Linking: Along Curve: Valid horizontal lead arcs could be discarded due to floating point precision issues. This has been fixed.



7954: Linking: The default 'Stay on surface, distance has been changed to make it dependent on the cutter diameter. Area Clearance, Core Roughing, Horizontal Areas, and Core Horizontal Areas use the formula  $5 \times$  cutter diameter, up to a maximum 'Stay on surface' value of 300.

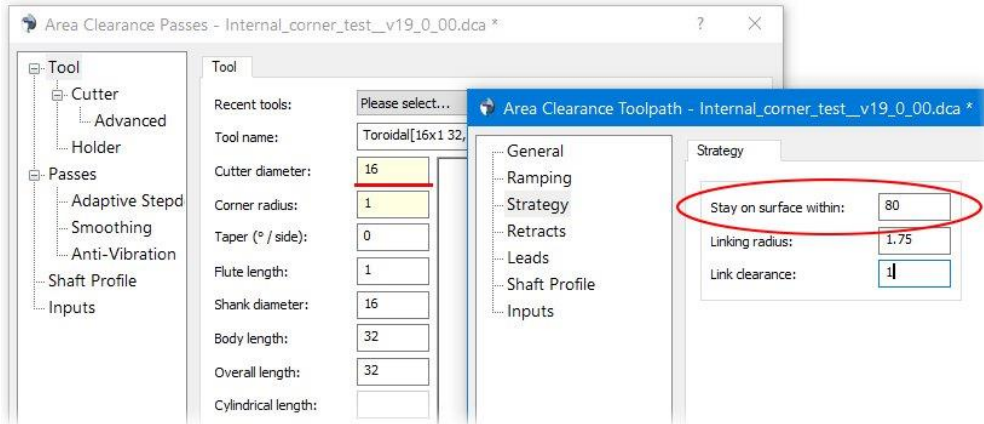

The Adaptive clearance also calculates the 'Stay on surface' value from the cutters diameter but uses  $10 \times$  cutter diameter again up to 300 as maximum.

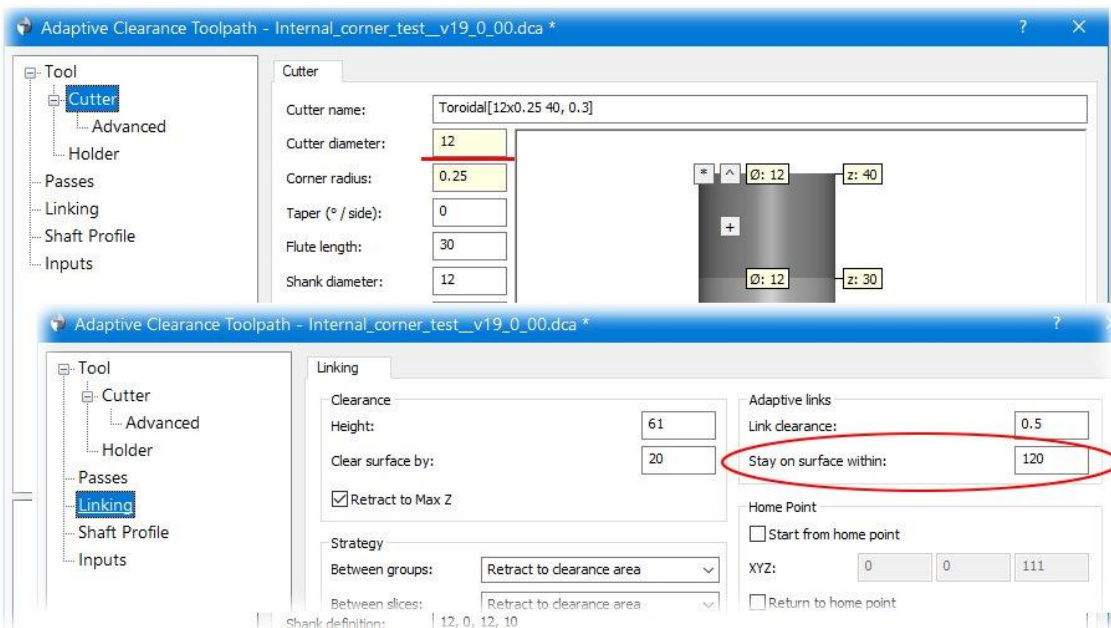

7965: User Interface: Improved performance of updating items in the graphics window.

7973: Adaptive Clearance: An option to do a final profile pass on each slice or on the last slice has been added to the dialog.

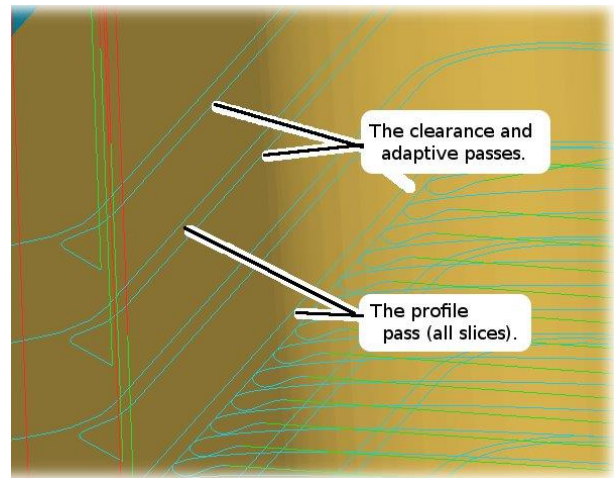
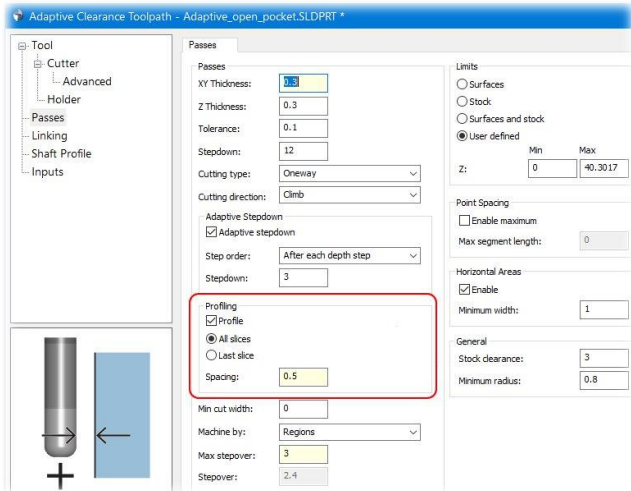

The clearance and adaptive passes hold off slightly, the profile pass then goes to size while respecting the thicknesses.

This extra pass will give a better surface finish in most cases.

7988: Linking: Improvements have been made to reduce the height or retract moves when linking rest passes in vertical corners.

7999: Import: Allow rearranging order of composite curve to reduce gap for CATIA V5 R19 files.

8010: Import: There were occasions when reading surfaces from an IGES file using the Convert to NURB option, would not read in all the surfaces, this has now been fixed.

8011: Import: Changed the surface colour loading for step files, priority is given to a correctly defined style, if the style is incorrectly defined, all styles will be read.

8037: Drilling: Centre drills (also known as slocombe drills) are now supported for drilling cycles.

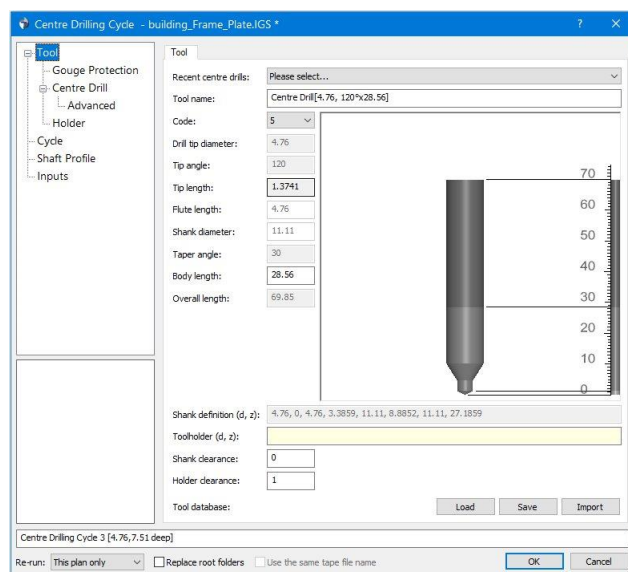

8053: User Interface: The wording on the context menus for copy/paste on a dialog have been improved.

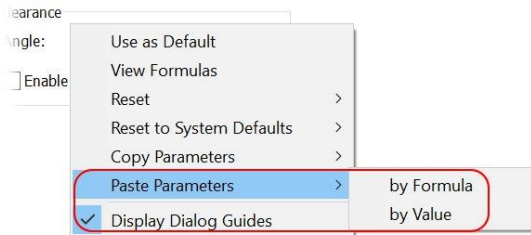

8062: Stock Models: Intersecting Multi-axis stock models, or subtracting one from another, sometimes did not give the correct result. This problem has now been fixed.

8063: Macros: Fixed a problem causing the running of drilling macros on editable drilling data plans to fail. Note when we make a non-editable copy of an editable drilling data plan, or an editable points plan, we now retain the plan label if it was changed from default. This is consistent with the existing behaviour for editable boundary plans.

8073: Stock Models: Add an option to create a revolved surfaces around an axis (X/Y or Z only).

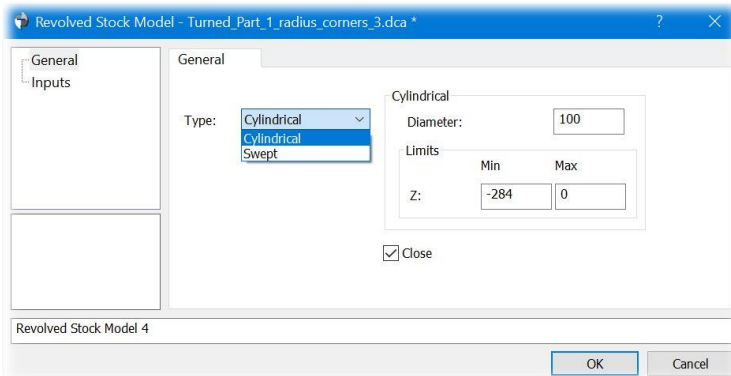

8079: Transform: Fixed a problem where rotating or mirroring a curve which itself was extracted with a rotation could go wrong.

8080: User Interface: Created folder plans are now drawn by default if any of the plans in the folder are drawn

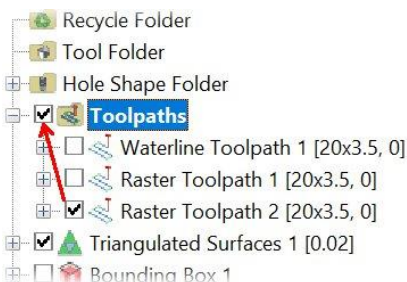

8083: Not having a valid project settings folder prevented the backup macro from being written to the program data area. This has been fixed.

8084: Post Processors: ISO, Siemens, and Heidenhain: Added the option to "Output the cutter's required body length" as a comment, by default this is set to false so as not to modify existing post processors. It also needs the pre-existing "Output the cutter's body length" to be set 'true' too. If there is no required body length, "Not available" will be output in the comment.

It is also output for the G-Post / APT, but has no option, as it will be reprocessed within G-Post, if there is no required body length, 0 will be output.

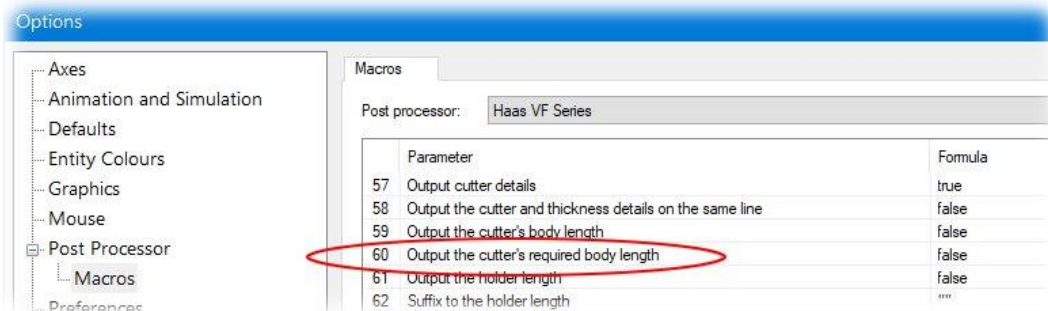

8085: User Interface: The context menu on plan dialogs was not enabling the option to reset tool page parameters correctly, this has now been fixed.

8095: User Interface: It is now possible to select more than 2 stock models to union together.

8096: Stock Models: When creating a Prismatic Stock Model from a Bounding Box with a rotation the result was incorrect, this has now been fixed.

8100: Along Curve: A warning message about loops in the passes was being triggered inaccurately in some cases. This has been fixed.

8107: Shaft Profile Analysis: We were picking up the tool name from the input passes plan. This would not correctly handle the addition or modification of holders. We now generate the tool name from the present selection.

8109: Stock Models: We can now perform a Geometry > Analyse on 3D stock models to count the number of triangles.

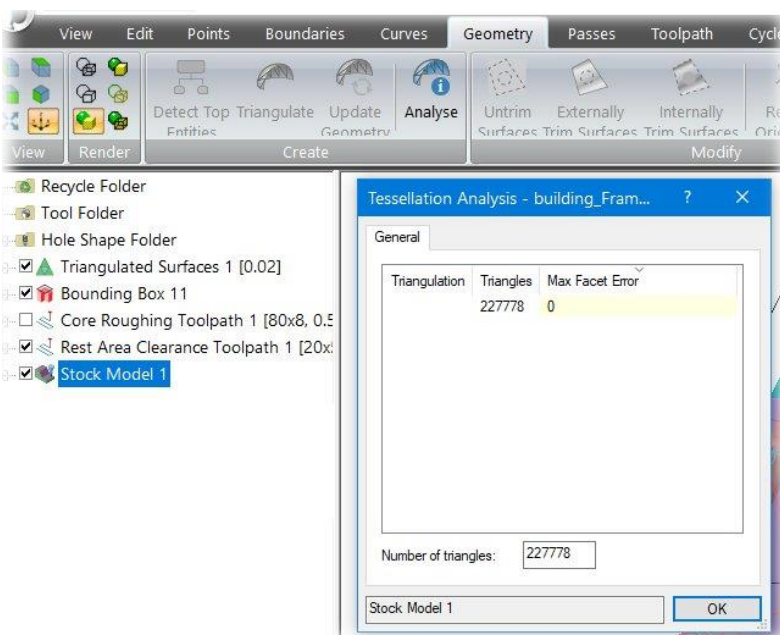

8123: Detect Holes: The accuracy of the detect holes operation has been improved to allow holes of similar, but different, rotations to be distinguished.

8133: User Interface: The "Preserve Root Folders" option has been added to the Five-Axis Conversion dialog.

8135: Cutter Animation: The text 'Programed Feedrate:' was being truncated and only showing 'Programed', this has now been fixed.

8138: Drilling: When detecting holes and creating drilling data we now attach colour information. Additionally, any hole shapes can be defined with colour and used as an additional search criteria to identify hole types for compound drilling cycles. Also fixes a problem where duplicate holes could be added to collections.

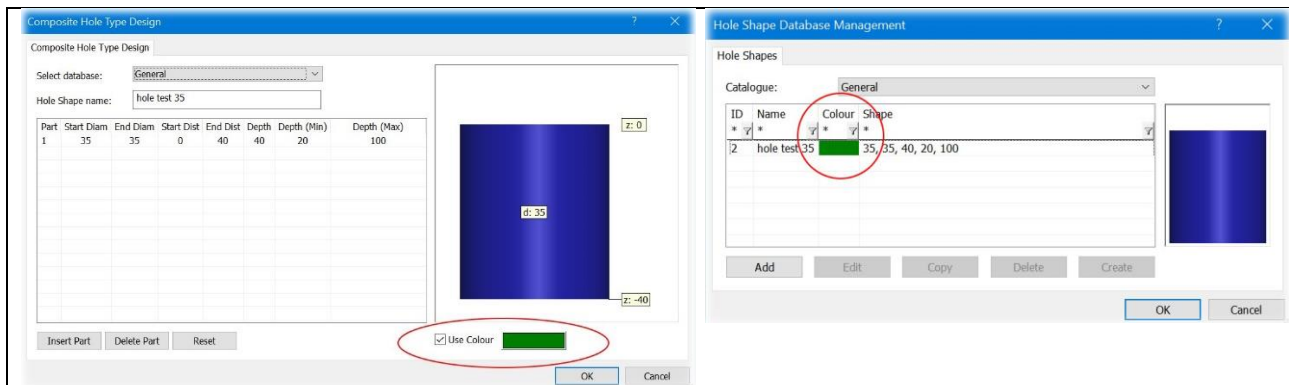

8140: Cutter Simulation: There were occasions when creating a stock model would ignore the modified Z Limits, this has now been fixed.

8146: User Interface: Any collision points and compensated toolpaths will now be drawn automatically whenever a toolpath is set to draw in the tree view

8148: Post processors: ISO, Heidenhain, and Siemens: Added the option "Start point: 3 axis move (3+2 only)" so that the start point can be performed as a XYZ motion in the same block, if the toolpath is a 3+2 toolpath. (A 3-axis toolpath will move XY, then Z or Z then XY depending on the existing "Start point: move Z axis before XY" post setting. By default, "Start point: 3-axis move (3\_2 only)" is set false so not to affect existing post processors.

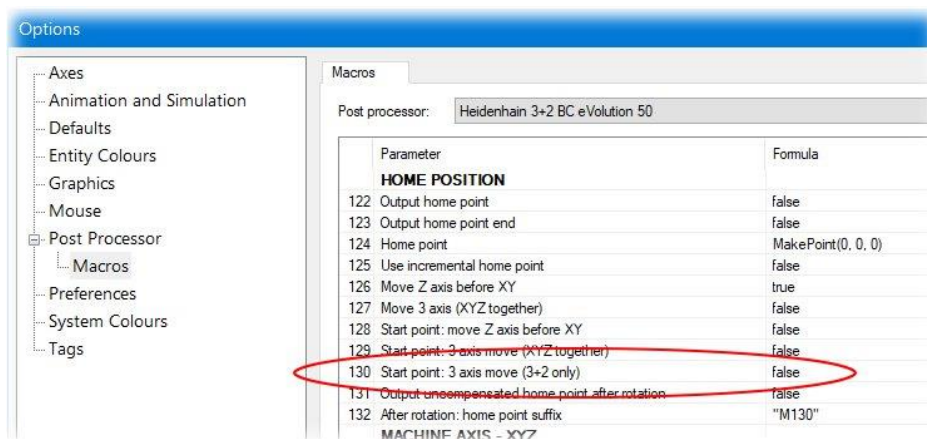

8149: User Interface: Boundary grid was not centred correctly in rotated views. This has been fixed.

8150: Linking: Waterline Offset Toolpaths were not always respecting the "min Profile Diameter". This has been fixed.

8156: User Interface: Add a tool comment option onto the cutter's advanced page. It can also be stored in the tool database and optionally output into tape file as a comment.

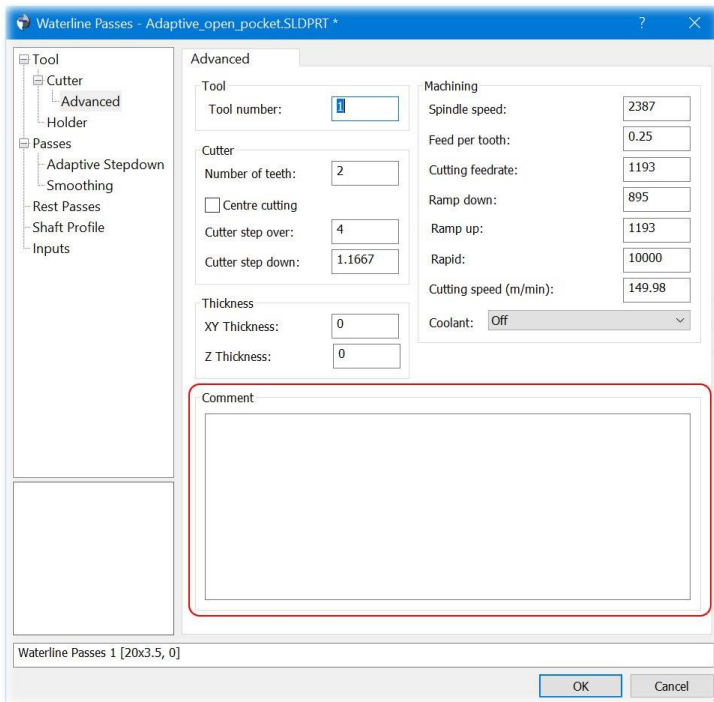

8157: User Interface: The grid size and holder and shank definitions now import correctly from the interactive tool design when the units are set as inches.

8158: On the Triangulated Surfaces or Triangulated Curves general pages, a Colour option had been added when re-triangulating.

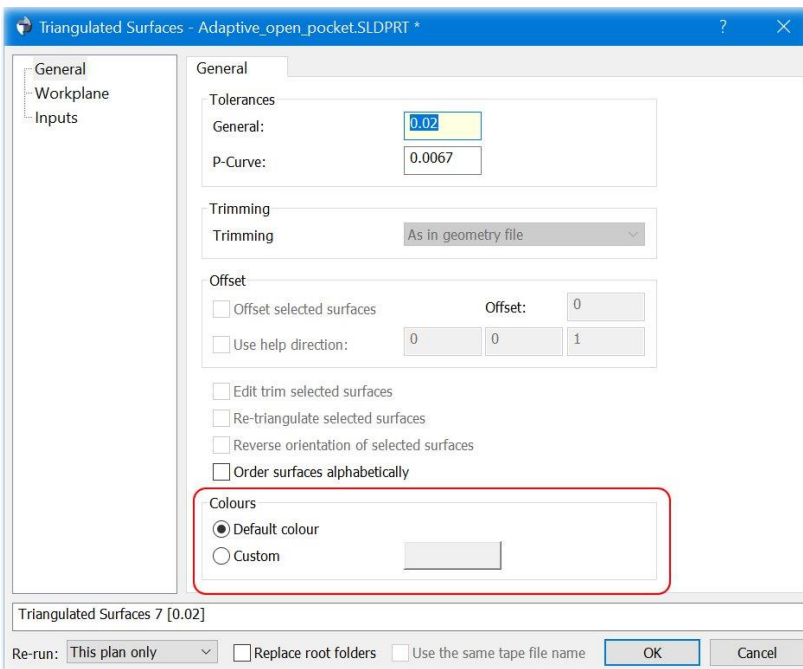

8161: Import: Display support for NX version 2000.

8163: User Interface: Added a Default Macro Folder in Options > Defaults.

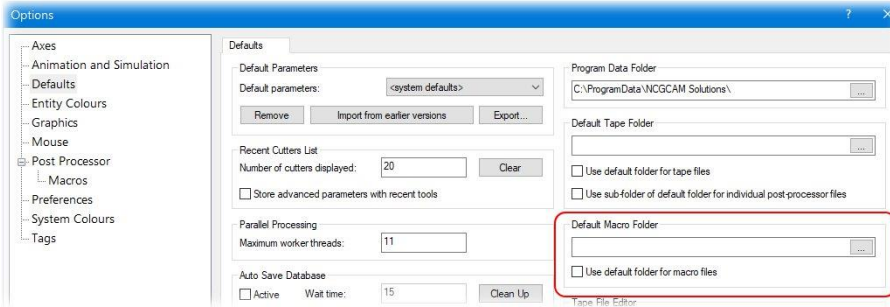

This allow any macros used regularly to be placed in a common folder, and then selected more efficiently as there is less searching.

8165: Adaptive Clearance: The default cut tolerance when thickness is applied has been changed so that it will not be greater than 0.1, this is to stop polygon shaped lead-in and lead-out arcs.

8168: User Interface: Improvements to Drilling Cycle dialog, the drill is now overlaid the hole so the depth can be checked, also the colour of hole denotes if it is blind or through.

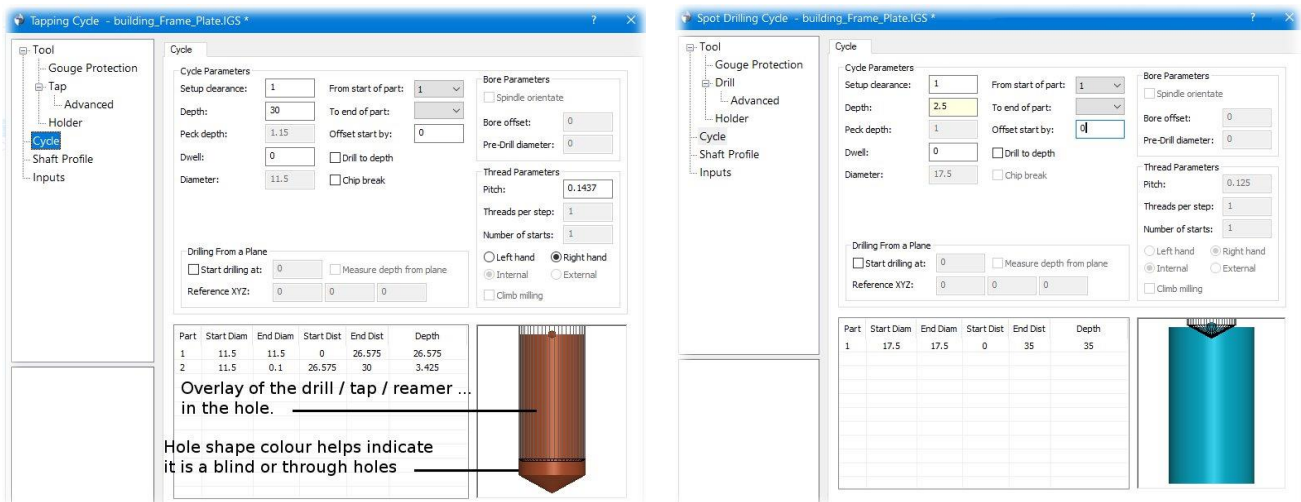

8172: User Interface: Removed the "Show User Advanced Page" option from the 5-axis dialogs.

8178: User Interface: Along Curve Passes: We no longer pop the bounding box dialog to set a rotation model if the input curve has no underlying rotation.

8180: User Interface: The Radial and Spiral Passes dialog, it is now possible to use a mouse hit in the graphics area to set the centre point of the passes.

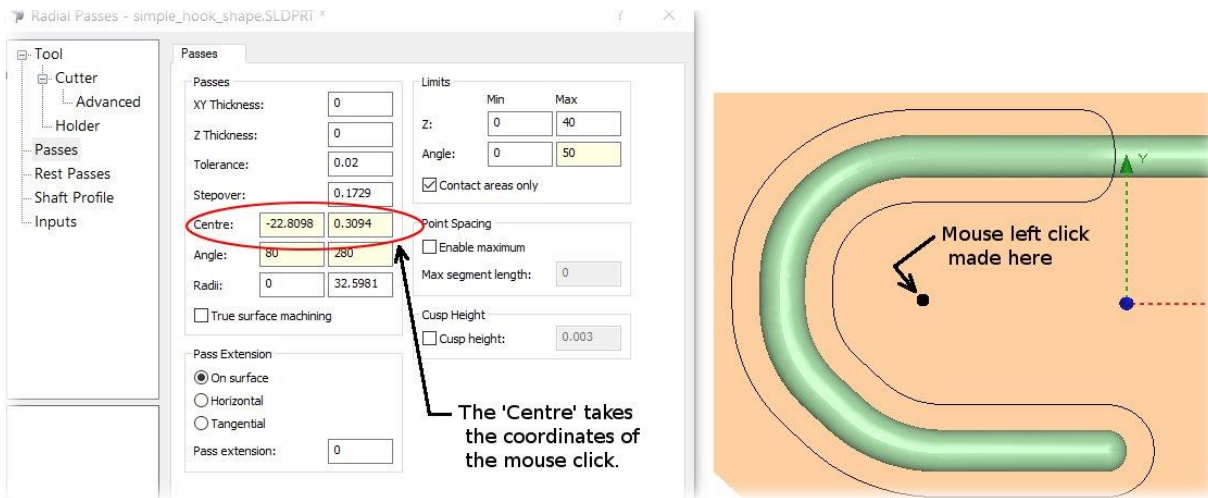

8193: User Interface: Prevented the tree view scrolling / jumping when re-running expanded plans and the tree is longer than the screen height.

8194: Detect Holes: the axis restrictions were not always being applied correctly to the rotations when detecting holes. This has now been fixed.

8195: Post processors: Heidenhain: Add the facility for a 'Spindle speed suffix', by default nothing is set, so existing posts will not be affected.

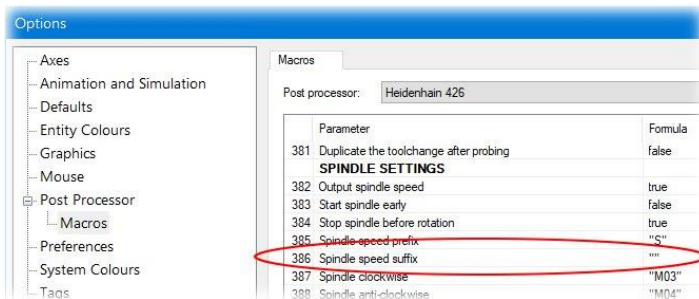

8196: Cutter Simulation: The default collision tolerance used was not consistent with that used for Machine Simulation, leading to different and misleading results for the same toolpaths. This problem has now been fixed.

8200: Cutter Simulation: There were occasions when Simulating multiple toolpaths that the cutter was not always being drawn, this has now been fixed.

8203: User Interface: The labelling of editable boundaries plans created by running properties on another editable boundaries plan has been improved to be clearer and more useful.



8204: User Interface: The default colour of Blind Holes has been modified to make them stand out better.

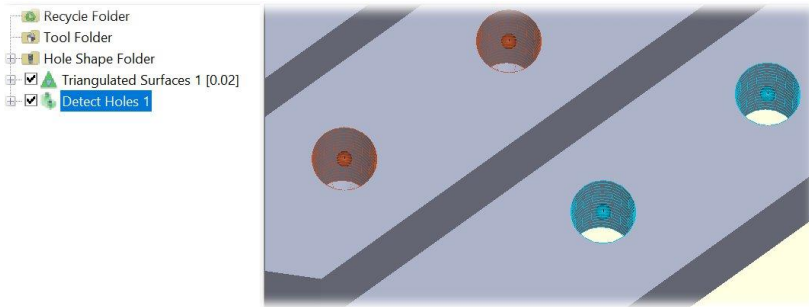

8211: Detect Holes: The axis restrictions were not always being applied correctly to the rotations for the drilling data. This has now been fixed.

8215: Adaptive Clearance: Will create Helix moves instead of line segments where ever possible for ramping sections.

8216: Selected Surface Waterline: Toolpaths based on selected surface waterline passes could include unnecessary linking moves in some instances. This problem has been fixed.

8225: User Interface: Fixed the tree view flickering when running a plan.

8226: The auto-save macro and auto-save database now include plans from all open graphics windows, rather than just the one currently active. Also fixed a case where the program would not exit correctly.

8228: Along Curve Passes: A problem existed which meant in places the passes might not follow the supplied curves. This has been fixed.

8238: Cutter Animation: There were rare occasions when animating a toolpath would not display the holder the first time it was animated, this has now been fixed.

8245: Triangulation: When Editing a surface (Untrim, Externally trim, Internally trim, Offset or Reverse direction) the newly created triangulated surface uses the surface tolerance from the input plan. Before it would revert to the import tolerance.

8247: Five-Axis: Surface machining plans were not using the correct default Clearance height when a rotated boundary was selected, this has now been fixed.

8248: User Interface: The depth shown in plan labels for Drilling Cycles now includes the depth adjustment distance.

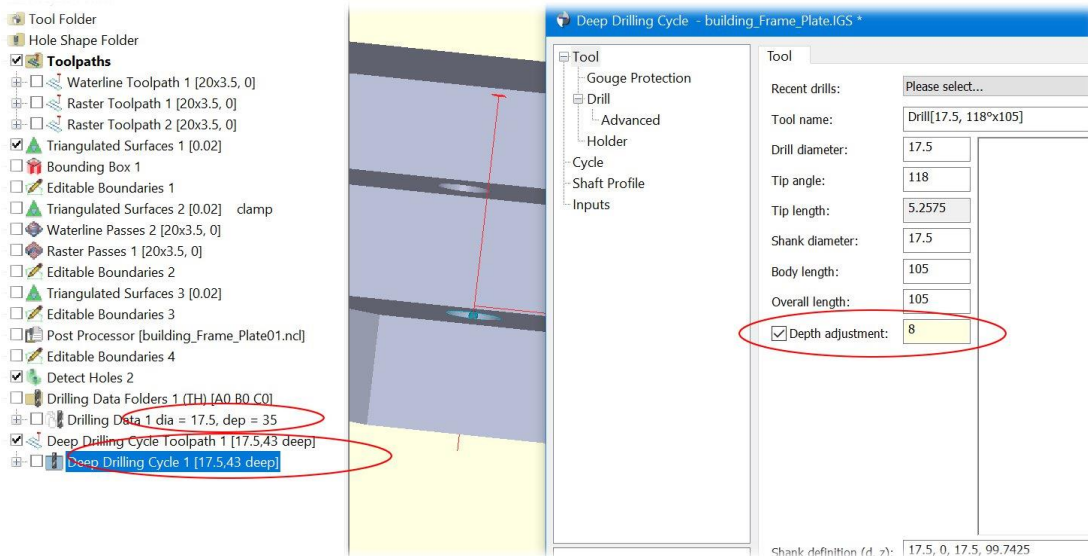

The hole is detected as 35 deep, in the drilling cycle a Depth adjustment of 8.0 was set, so in the passes and toolpath, a depth of 43 is displayed.

8258: User Interface: Fixed Cutter Simulation stock not being captured when saving the view to a bitmap or printing.

8277: Selected Surface Waterline: A problem has been fixed where selected surface waterline passes would sometimes not be calculated when XY and Z thicknesses were different.

8290: Tool Database: Removed the option "Import From Old Database" from the Tool Database libraries page as it is no longer functional.

8303: Horizontal Area Passes: It was possible when the Z min and max limits were equal to miss a planar surface which should be detected. This has been fixed.

8313: ModuleWorks: Updated to new MW2022-12 Libraries.

8314: Import: Fixed a crash that could occur while loading a geometry file.

8322: A macro created by DEPOCAM could crash if it created an empty boundary. This has been fixed.

8325 & 8370: User Interface: Dialog guide graphics have been added to the Stock Model dialogs to display a Translucent plane at the Z Min and Z Max limits, also a cylinder will be drawn for a revolved stock model.

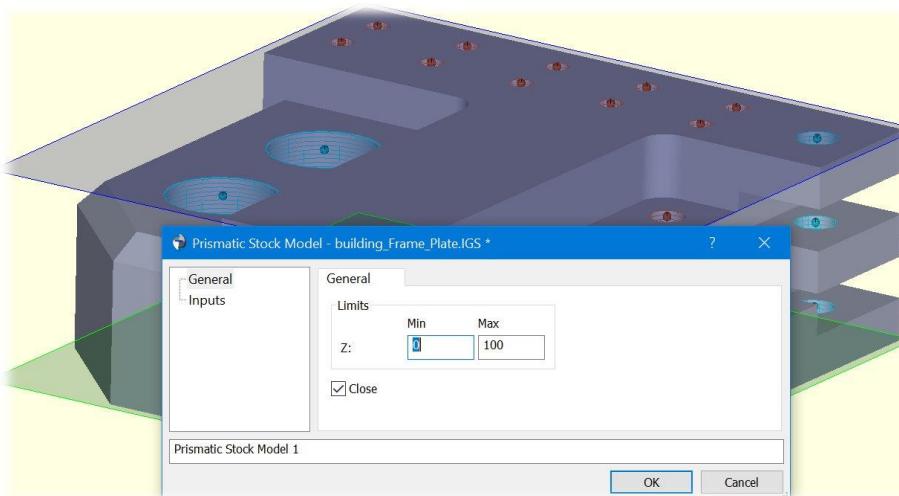

There is also new option in the Plan dialog context menu, so that you can now toggle the dialog guide graphics on and off.

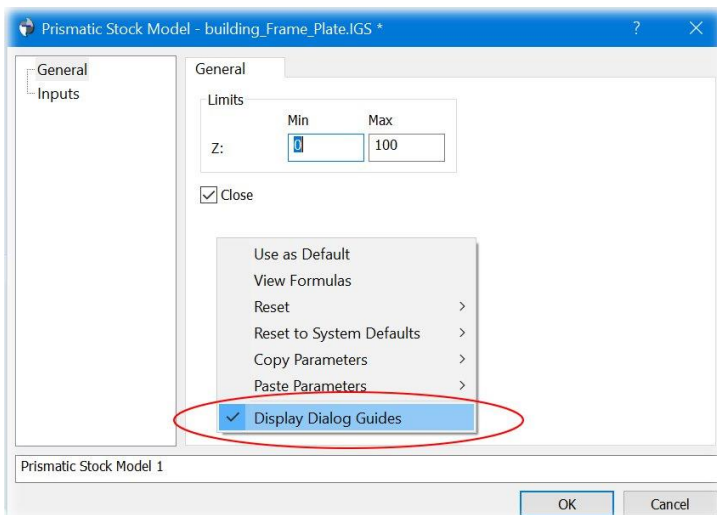

8329: User Interface: Disabled ribbon shortcuts when editing labels in the tree view

8331: Rest Machining: There was a problem when using a transformed stock model as input when editing passes, an exception could be thrown, this has now been fixed,

8340: Post Processor: when using a Proxy Post Processor on multiple files the process was not completing correctly, this has now been fixed.

8344: User Interface: Nested folder plans in the tree view are now updated correctly when a plan is added to the bottom folder plan. Improved performance when populating the tree view.

8357: Macros: The recycle folder will now not be output in written macros.

8366: ISO, Siemen and Heidenhain Master posts. Added the option to output the cutter details / description as a comment prior to a tool change. By default, it is set 'false' so as not to affect existing post processors. The new parameters being 'Output cutter details', 'Current cutter details Prefix', 'Text Prefix for the 'drill' diameter', 'Text Prefix for the cutter diameter', and 'Text Prefix for the cutter corner radius, and Text separator between diameter and radius'. Help files updated to match

Macros

Post processor: ISO Master File

Parameter	Formula	Type
26 Output engineer's name	true	bool
27 Output project comment	true	bool
28 Output cutter details	false	bool
29 Current cutter details Prefix	""	string
30 Text Prefix for the 'drill' diameter	"Drilling tool: "	string
31 Text Prefix for the cutter diameter	"Cutter: "	string
32 Text Prefix for the cutter corner radius	""	string
33 Text separator between diameter and radius	"x"	string
34 Output the previous tool details before a toolchange	false	bool
35 Previous cutter details prefix	"Previous tool details: "	string

8373: ISO, Siemens and Heidenhain, including the Master-file posts for those formats. Added the option 'Output previous cutter details before a tool change', if set true the basic details of the previous cutter (for example: T5 6x0.5) can be output as a comment, just before the tool change.

It can also use the additional options: 'Previous tool details prefix' and 'Previous tool details suffix' to aid with any additional formatting that is required, that were also added.

ISO and Siemens: Some pre-existing options like the 'Tool number prefix' are used for the 'T' in the example above.

Heidenhain: Because the Heidenhain typically uses 'Toolcall' or 'ToolDef' as the 'Tool number prefix' it is not used. But the 'Previous tool details prefix' can be used to output a "T" before the tool number.

Macros

Post processor: ISO Master File Roders

Parameter	Formula	Type
28 Output cutter details	false	bool
29 Current cutter details Prefix	""	string
30 Text Prefix for the 'drill' diameter	"Drilling tool: "	string
31 Text Prefix for the cutter diameter	"Cutter: "	string
32 Text Prefix for the cutter corner radius	""	string
33 Text separator between diameter and radius	"x"	string
34 Output the previous tool details before a toolchange	false	bool
35 Previous cutter details prefix	"Previous tool details: "	string
36 Previous cutter details suffix	""	string
37 Comment start	"("	string
38 Comment end	")"	string
39 Start mode	"Macoor -all\nLoadzero="1"'"	string
40 End mode	"cleanoff\nTim -clean -r=2.9"	string
41 End of program stop	"//Moff\nM30"	string

UNITS & FORMAT

If post processing a master-file and sub-files, the 'Previous tool details' can only appear in the master-file, not the sub-file. If the tool change is not output in the master-file, only the cutter size is output as a comment. The default setting for 'Output previous cutter details' is false, so existing post processors are not affected.

The help files have been updated to match.

8378: User Interface: "Paste Parameters > by Value" has been disabled in the Cutting Parameters dialog. Copying values here could change things like plan names, which would cause confusion.

8381: User Interface: Fixed a memory leak caused by opening dialogs.

8387: Export: Writing surfaces as a RAW file could fail if a surface was empty. This has been fixed.

8392: Cutter Simulation: It is now possible to display the simulation with transparency enabled.

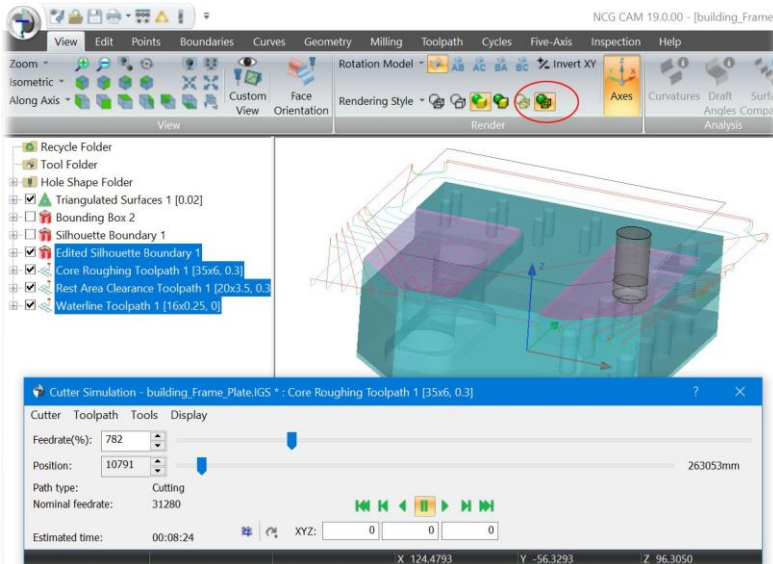

8393: User Interface: Corrected the description of the Boundary on Surface Plan in the database window.

8397: User Interface: Fixed the tool definition icon not updating when added to the quick-access toolbar.

8399: User Interface: When changing the Co-Ordinate plan in the inputs page of a machining dialog the origin values were not being reset to 0.0, this has now been fixed.

8403: User Interface: Fixed a crash when drawing a surface or stock model with an extremely large number of vertices.

8408: User Interface: The 3D Tool Guide will now use the rotations from the selected Drilling Data or Drilling Data Top Folder plan, as it currently does from Boundary plans.

8409: User Interface: The creation of Five-Axis tools in the tool database has been disabled if there is no Five-Axis license.

8412: User Interface: Fixed the printing page scaling modes not working correctly when the "OpenGL printing" option is set.

8413: User Interface: Fixed "Maximise view scale" not working correctly when a datum point is drawn. The height at which boundaries are drawn is no longer affected by the datum point axes.

8414: User Interface: Using "Maximise view scale" when only a single point is drawn will now centre the view on the point and reset the scale to 1.

8421: Linking: Fixed a problem which meant Waterline passes generated with highly tapered cutters could be linked out of order.

8431: Import: Update Datakit libraries to 2022.4. Supports Parasolid V35.0 and the latest NX version 2206.

8432: Machining: fixed a program crash when calculating horizontal area passes.

8436: Machining - improved the error handling when passes are created with invalid protection surfaces.

8437: Linking: Fixed minor gaps in toolpaths due to numerical inaccuracies.

8438: Waterline Machining: when invalid protected surfaces are selected, the dialog will now give a validation failure.

8439: Detect Holes: Fixed an exception thrown when detecting holes on a raw surface.

8440: Badly formed edited plans now fail more cleanly.

8441: Detect Holes now works correctly when input folders are combined.

8442: Triangulator: Fixed the exception that could be thrown when generating triangulated surfaces from a 2D stock model. Note that though the exception is fixed, no triangles are produced.

8443: Fixed an exception that could arise when linking core horizontal area passes.

8447: Machining: Fixed an exception that could be generated when calculating horizontal area passes

8449: Linking: Along Curve Passes: We now use the passes cutter compensation setting before the cutter offset setting to better determine which side of along curve passes to try and position lead arcs.

8450: Surfaces: 2D stock models are no longer accepted as an input to triangulation.

8451: User Interface: Improved selection performance.

8454: User Interface: The option to design a shank or holder on the tool pages has been disabled if a tool has been selected as an input.

8460: Post Processors: ISO: Added an option 'Cycle definition uses X Y position only', for the canned cycles to allow only the XY position of the hole to be output within the cycle. The default setting is false, so existing post processors are unaffected.

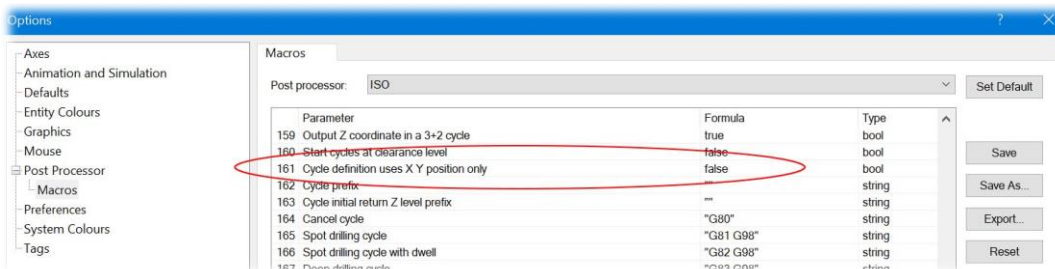

8462: 3D Tool Guide: Performance improvement.

8463: Cutter Animation: The display of Barrel cutters with Wireframe with the default settings has been improved.

8465: Post Processors: ISO: For a particular machine control, the spindle needed to be restarted before every tapping cycle. Added the option "Restart spindle before tapping cycle", this is set false by default so existing post processor are not affected.

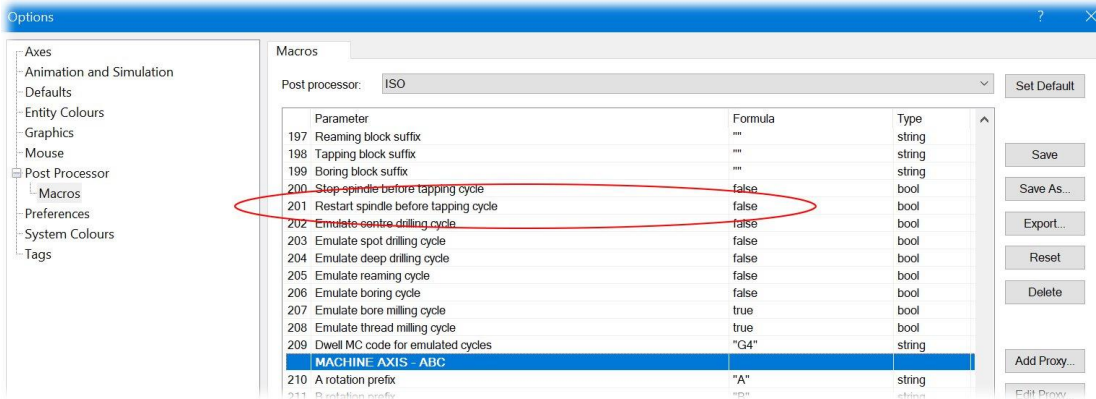

8468: User Interface: The status bar RGB value (if enabled in the user Preferences) is now only set when selecting a single item.

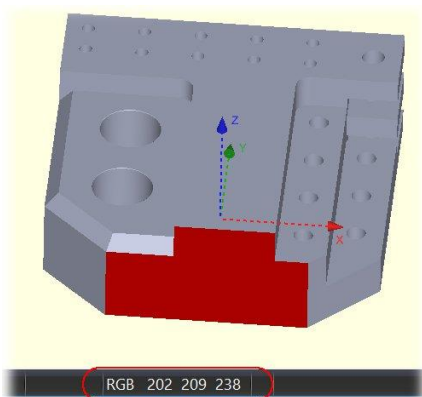

The RGB value with a single item.

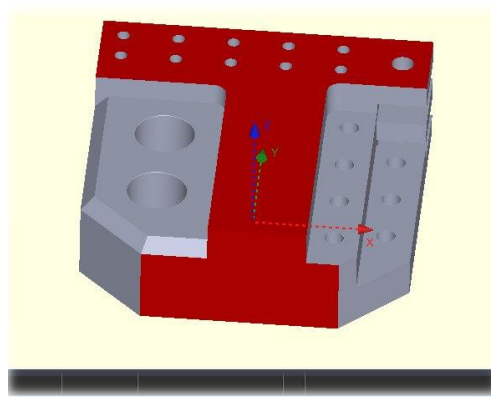

With multiple items selected, the RGB is not shown.

8477: The GPost APT post now outputs the projects Prefix and Folder as PPRINT comments. This is additional information and will not affect any existing GPost post processors. This will not affect any exiting posts.

8478: User Interface: Dialog guide graphics have been added to the ZTrim Stock Model option.

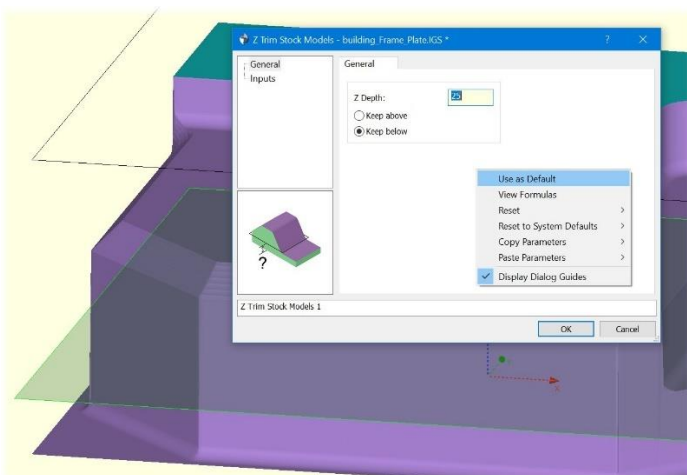

8479: User Interface: Improved the selection performance.

8482: Linking: Fixed a problem which could introduce bad vertical arcs into toolpaths during a shortest route connections.

8485: User Interface: Fixed edges not always being drawn correctly with the "Shaded with Edge" and "Wireframe HLR" drawing modes.

8486: User Interface: Improved graphics performance of the inspection results.

8489: Tool Database: It is now possible to import tools from a tool database text file into the Tool Folder.

8487: User Interface: Improved the selection performance when drawing running plans.

8501: User Interface: Fixed a check box being added to the recycle folder.

8502: User Interface: Improved the graphics performance when drawing overlays like the drag box.

8504: User Interface: Fixed the bottom tree view item being cut off when loading a database with a large number of items.

8506: ModuleWorks: The validation for Taper angle has been updated as when using a Taper Mill in Five-Axis or Adaptive clearance plans the taper angle must be between 0.1 and 89 degrees, otherwise an exception will be thrown.

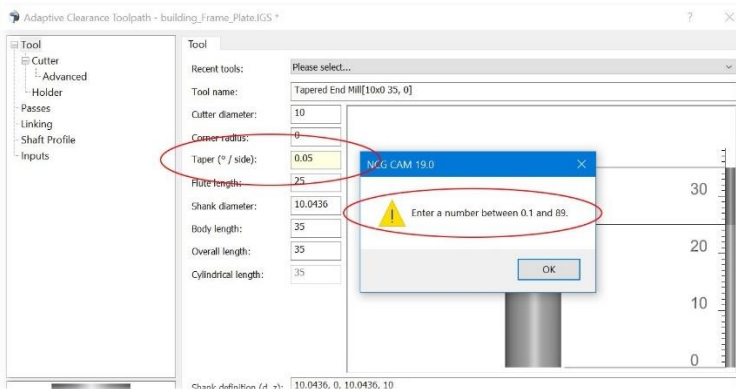

8507: Stock Models: There were occasions when supplying a flat plane as a stock model input to a plan would cause an exception, this has now been fixed.

8512: Database loading: An exception is no longer thrown when attempting to insert an empty file into a database.

8514: Toolsheets: The length of axes in toolsheet images, was set by the general axes length option, is now treated as a fixed length relative the rest of the geometry in the image.

8515: Linking: The default Helix diameter has been changed so it is calculated from the actual tool used (not adjusted by the thicknesses). Note this will change the default horizontal lead arc radii for Helical and Waterline style passes.

8516: User Interface: Removed "Use accelerated OpenGL" graphics option page.

8517: User Interface: Fixed an issue with the selected dynamic rendering style not always being used.

8518: User Interface: Reduced time taken for completed plans to be updated in the graphics view.

8520: Machining: Selecting a collection of boundaries as constraint boundary for passes caused the program to fail. These are now removed from the list of acceptable inputs.

8524: UV Passes: The UV passes could sometimes hang DEPOCAM, this has now been fixed.



8525: Toolsheets: Added "Cut Tolerance" to the CSV toolsheet.

8526: Toolsheets: Fixed calculation of toolpath "Min Z" value.

8527: Toolsheets: Fixed CSV toolsheet generation failing with 5-axis toolpaths.

8528: Toolsheets: Added the part image path to the CSV toolsheet.

8529: Toolsheets: Added part lengths and centre point to the CSV toolsheet.

8540: Post processors: ISO, Heidenhain and Siemens: The work offset is only output when it changes and the "Performance over spindles RPM check" option is set 'true', this avoids duplicate work offsets being output.

8551: User Interface: Improved performance when organising the tree view.

8554: User Interface: Improved tree view performance.

8555: Thicknesses: A problem has been fixed where, when an oversized negative thicknesses is enabled and the net negative thickness is exactly half the cutter radius in size, a validation error occurred, erroneously.

8559: Fixed an exception that could be thrown when calculating along curve passes.

8561: Toolsheets: When viewing an XML toolsheet through the context menu the default is now to launch an Internet Explorer window (not Edge), including Windows 11. This is set in the DEPOCAM, Options > Defaults > Toolsheet > Browser > Viewer, which needs to use: - \Program Files\DEPOCAM 19.0\Macros\LaunchIE.vbs

8563: Master post processors, ISO, Heidenhain and Siemens: Added the option "Output Machine safe position" which allows the machine safe position to be output or not. The default is true, as the machine save post was always output before, and is considered the safer approach.

There are also four additional parameters for the feedrate variables, "Rapid feedrate suffix", "Ramp down feedrate suffix", "Cutting feedrate suffix", and "Ramp up feedrate suffix", nothing set for these by default so existing posts are not affected.

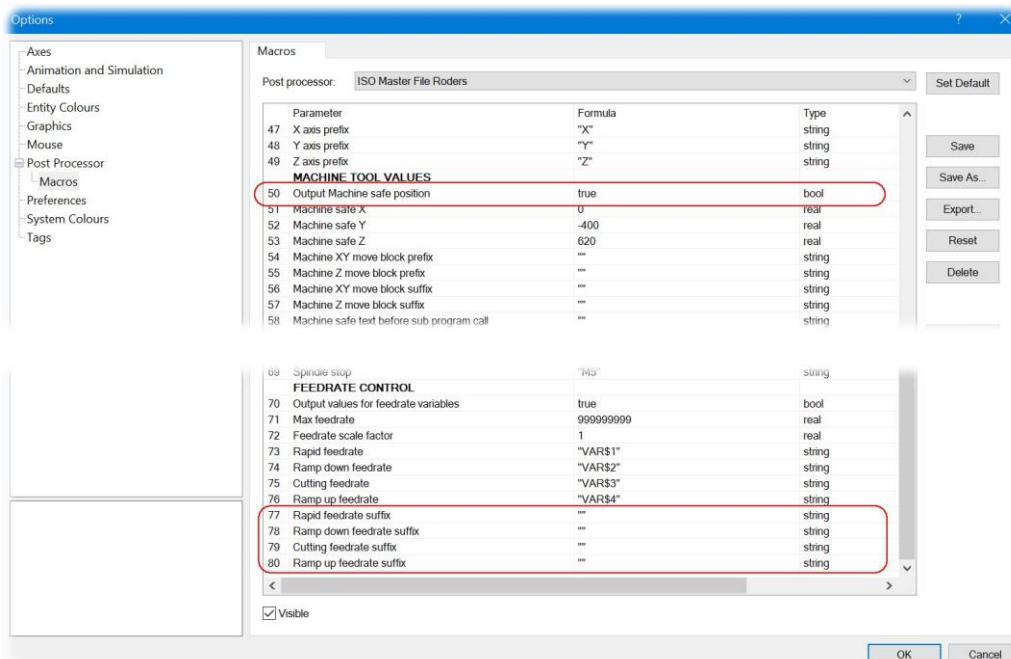

8564: Tool Database: There was a problem saving a tool from the tool page which had previously been imported from a text file, this has now been fixed.

8570: Export: Saving a file as VRML which contains tessellated curves, would fail to output the curves, this has now been fixed.

8574: User Interface: Fixed a crash that could occur when creating a folder plan.

8578: Export: Saving a file as VRML which contains tessellated points, would fail to output the curves, this has now been fixed.

8580: Import: Improved performance when loading a geometry file with the "Load Component Information" option enabled.

8586: Database: Fixed a crash that could occur when loading old databases.

8590: User Interface: Fixed plans in the tree view not being replaced when setting the coordinate system with the "Re-Triangulate when setting coordinate system" option enabled.

8617: Import: A performance improvement has been made to reduced time taken to load files with large numbers of components.

8623: User Interface: We now block Folder Plans as inputs to Bounding Box and Stock Model, and Collections where they are inappropriate inputs to the other plans.

8627: User Interface: It is no longer possible to change the coordinate system input to an Transformation plan through the inputs page, since doing so would have no effect.

8628: Coordinate System. The behavior of the coordinate system plan dialog was wrong and has been corrected.

8632: Import: Small correction has been made when getting surface colour for Granite files.

8633: Import: Improved the performance of loading database archives.

8644: Rebuilt the general and five-axis tutorials for DEPOCAM.

8646: User Interface: Invalid characters are now removed from project settings automatically, this prevents characters like \*, ?, >, / being used as part of a prefix or folder name.

8653: Transformation: The option to re-triangulate when setting coordinate systems was being incorrectly applied to edited transformed surfaces plans. This has been corrected.

8655: Toolsheets: When using selecting a Custom view, then rotations for the Toolsheet images set the current view rotation in the edit box automatically, the can still be edited manually if required.

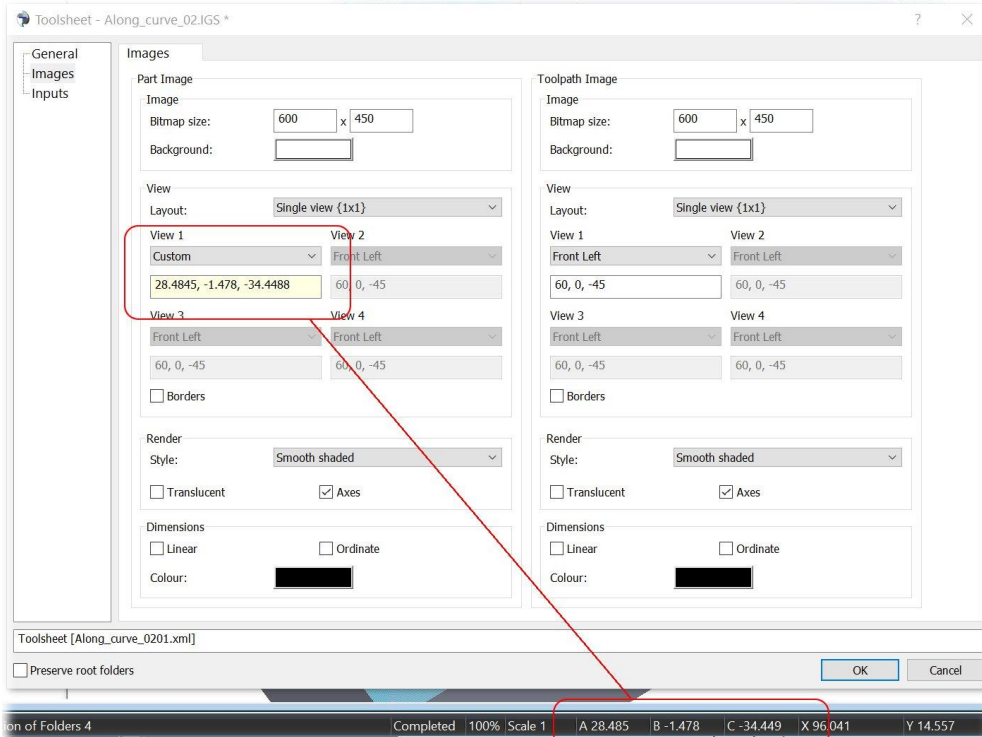

8658: Adaptive Clearance: The Overlap option has been added to the profile pass move, this is the length of overlap for closed profile passes add roughing levels.

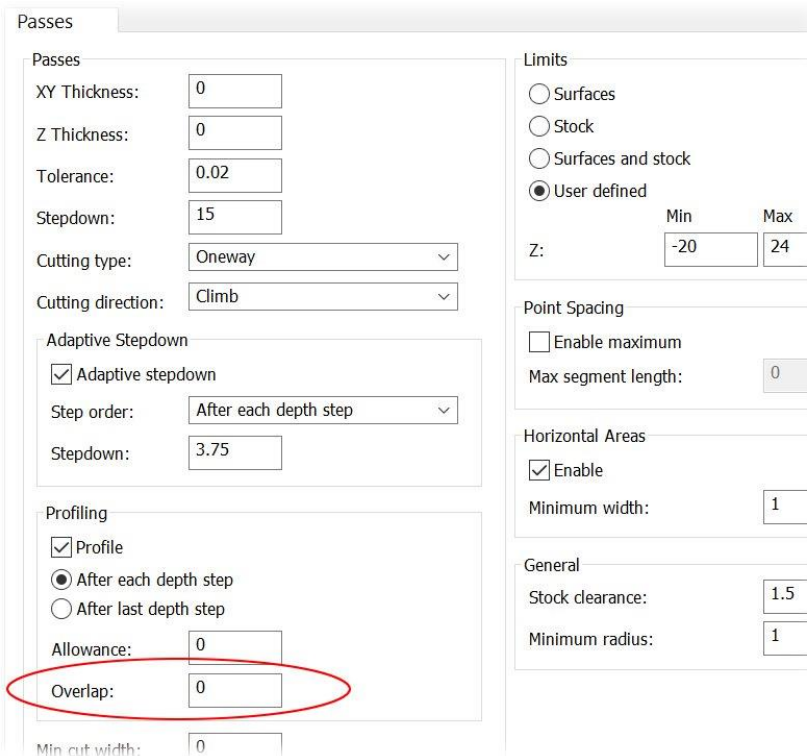

8664: User Interface: The wording in the Revolved Stock Model dialog has been changed from "Swept" to "Revolved".

8665: User Interface: Fixed an issue with the spheres in detect holes plans not scaling correctly in the graphics view when the viewing scale changed.

8675: User Interface: The problem where some right-mouse-button context menus had become disrupted and was not showing all the options it should has been fixed. This also fixes ticket 8696.

8679: Post processing: GPOST: A problem has been fixed where, wrongly, attempts were made to create Master Files when using GPOST for post processing.

8683: Detect Holes: Drilling Data Folders. Fixed a problem which could lead to empty Drilling Data Folders being created. Also fixes ticket 8666.

8686: Stock Models: The speed of calculating Multi-Axis stock models has been improved. The improvement is more noticeable with large toolpaths.

8688: User Interface: Prevented graphical views of the cutter / holder in dialogs being reset when changing values in the dialog, if you has zoomed in or panned the graphics.

8689: User Interface: Fixed a problem being unable to select entities through a clipping plane.

8693: User Interface: The dialog display guides for Stock models were not always drawn correctly, this has now been fixed.

8695: User Interface: The default ribbon category was being set to "View" after the interactive tool definition frame closes, it now restores it to the category it had previously been in.

8698: Tool Database: There was a problem saving canned cycle tools to the tool database from the tool/drill page that resulted in the drill diameter being set incorrectly. This has now been fixed.

8699: User Interface: In Option > Preferences > Open File renamed "Prefer 3D trimming for IGES files" to "Prefer XYZ trimming for IGES files" This is to be more consist with the DEPOCAM IGES file reader's option "Prefer XYZ".

8700: User Interface: The Circular Boundary dialog was not displaying all of the label for the "Centre (XY)" string, this has now been fixed.

8701: Tool Library: Export and Import as text options now supports shank definitions for drills.

8705: User Interface: The 3D Tool Guide was failing to get the correct rotations from a silhouette boundary plan, this has now been fixed.

8708: Post Processor: Heidenhain: Added the option 'Output toolpath details as a structured comment' which is false by default so existing posts are not affected. If set true, details of the cutter/drill will be output as a structured comment. For example: \* -Ball Nose [12.000x6.000 24.000, 0.200] for a ball nose 12 diameter, a body length of 24, and a thickness of 0.2 (, Z thickness if different) or for a M10 tap with body length of 60: \* -Tap [10.000x0.000 60.000, 0.000]. The Help file has also been updated to match.

8710: ToolDatabase: There was a problem when exporting a milling tool and the units were set to inches, the shank definition was being output in mm, this has now been fixed.

8714: User Interface: Improved User Interface performance.

8719: User Interface: Creating a prismatic stock model from a silhouette boundary could cause a crash, this has now been fixed.

8721: User Interface: Fixed an issue with surfaces that are not visible in the current view axis not being selectable. For example, a planar patch at Z 0, often was not selectable when viewing along the X or Y axis.

8728: Database: Fixed an issue with memory not being cleared correctly when closing a database.

8732: User Interface: Fixed a problem that could result in some graphical overlays not being drawn in the overlay colour.

8734: Five axis: The option to select a surface folder for tilting has been enabled in the ModuleWorks advanced dialog.

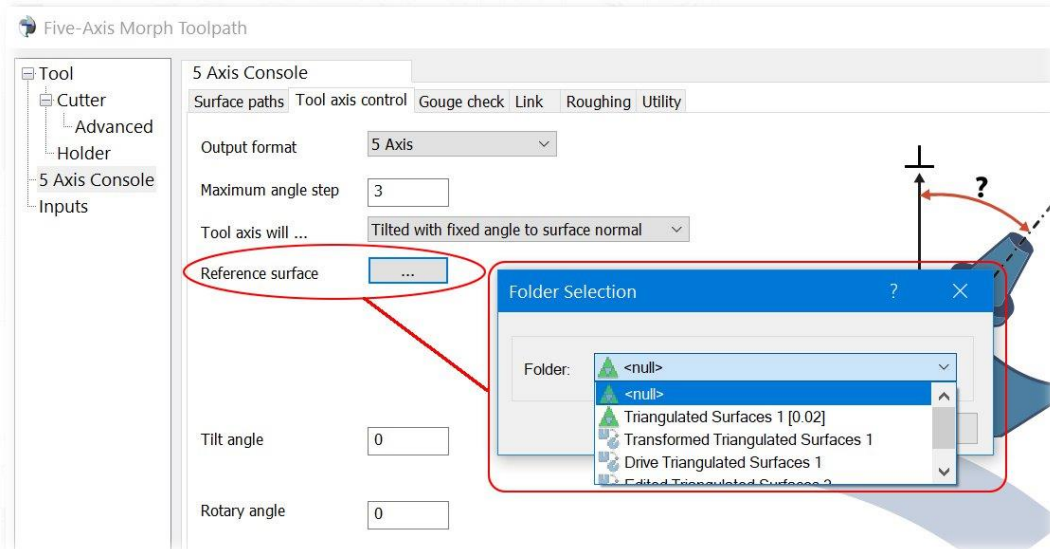

8735: Coordinate Systems: Creating a datum point plan from an embedded datum point (in a surfaces plan) was not handling the rotations correctly, this has been fixed.

8740: Coordinate Systems: It is now possible to transform multiple suitable plans, by selecting them along with a single "embedded" data point. This makes the behavior consistent with transforming using datum point plans.

8741: Import: When loading a geometry file with the "Load Component information" checked, component folders were being created which contained only one tessellated surfaces plan. This has now been changed so that in these cases the tessellated surfaces plans are placed in the next level above in the tree view.

8742: Post Processors: ISO and Siemens: If the 'Output toolchange' option was set false, the 'Start spindle early' option set true. The 'Start spindle early' was not respected, this has been fixed.

8745: User Interface: Improved tree view performance.

8747: User Interface: The context menu option to collapse or expand items in the tree view will now read "Collapse" when nothing is selected and no folder plan can be expanded.

8748: Linking: Waterline passes. Fixed a problem which could result in some waterline passes being linked out of order.

8753: Tool Database: It was possible to have a drill saved to the tool database and then used in a plan to by loading it and the diameter would be incorrect, this has now been fixed.

8754: Tool Database: The number of decimal places have been reduced when outputting a tool body definition to a text file, it is now restricted to 4 decimal places.

8755: User Interface: Fixed a problem that could occur when using the Shift key while creating interactive holders and chucks which caused DEPOCAM to crash.

8756: User Interface: Fixed transformed plans not being created in the tree view when setting the coordinate system of input plans.

8758: Linking: Waterline Passes: There was a problem with linking on surface ramping moves which in some cases could drop too far. This has been fixed.

8760: User Interface: The behaviour of the User Interface if an invalid shaft has been defined on the tool page has been improved.

8762: User Interface: It was possible to use a 2D Stock model as input to an Adaptive Clearance or Five-Axis plan this would cause an exception, this has now been fixed with 2D stock models being blocked.

8763: User Interface: Fixed a problem with the 3D tool guide stopping after holding an arrow key.

8767: Post-processing: Searches for toolpaths, macros, postable toolpaths, and inspection vectors have been extended to nested folders.

8773: Extract Curves: We were only thinning curves if fit horizontal arcs was enabled. This has been corrected.

8775: User Interface: Fixed the flickering that could happen when using the tree view, and the tree view is longer than the screen height.

8776: User Interface: The user interface is now not blocked when creating tessellation plans for geometry files with components, until all components have been loaded.

8777: Adaptive Clearance: There were some examples where ramp lead in/out arcs were not being output correctly, this has now been fixed.

8780: User Interface: Fixed a problem with the selection of rotated curves plans not working correctly.

8781: User Interface: Fixed an issue with surface plans created by trimming surfaces with boundaries not being organised automatically.

8783: Adaptive Clearance: The wording of Profile ordering options "All slices" and "Last slice" has been changed to "After each depth step" and "After last depth step" respectively for clarity.

The screenshot shows the 'Passes' configuration window. The 'Adaptive Stepdown' section is active, with 'Adaptive stepdown' checked and 'Step order' set to 'After each depth step'. The 'Profiling' section is also active, with 'Profile' checked and 'After each depth step' selected. A red box highlights the 'Profile' and 'After each depth step' options. Other settings include 'XY Thickness: 0', 'Z Thickness: 0', 'Tolerance: 0.02', 'Stepdown: 15', 'Cutting type: Oneway', and 'Cutting direction: Climb'.

8788: Tool Database: When loading tools into the tool folder from a text file, if the file only contains cutters or cutters which were not used in tools, these were ignored. We now read these in as a tool.

8802: Tool Database: Some sample turning tools have been added to generalnikken.txt.

8805: User Interface: Fixed graphics four-view mode not rendering correctly.

8808: User Interface: Improved performance of animations and overlays in the graphics view.

8812: User Interface: Fixed a crash that could occur when closing an analysis dialog.

8815: Stock Model: For revolved stock models we now set the default diameter depending on the geometry selected.

8826: User Interface: The parameter space view options can now be set for individual views in four-view mode.

8834: Machining. Improved the accuracy of rest passes when using small cutters. Cutters of diameter greater than 10mm should produce the same result as before.

8853: User Interface: Fixed an issue with the view axes being scaled incorrectly when switching to four-view mode.

8854: Linking: Area Clearance toolpaths. Increase the number of cases where we apply straight-line recovery moves if we fail to fit a smooth S-shaped connection because of the stay on surface distance and position of the linking move.

8856: Linking: Core roughing: We now preferentially machine nearby open core roughing passes before any closed passes in the offsets.

8861: Linking: We were discarding valid horizontal lead out arcs when an associated vertical arc could not fitted, this has been corrected.

8864: User Interface: Fixed a selection performance regression on Intel integrated GPUs.

8867: Import: Datakit libraries have been updated to 2023.2. Supports CATIA V5 R33, Parasolid V35.1 and UG NX2212. Please note, the color setting may not be accurate for the current release, and it will be fixed at by ticket 8882 later.

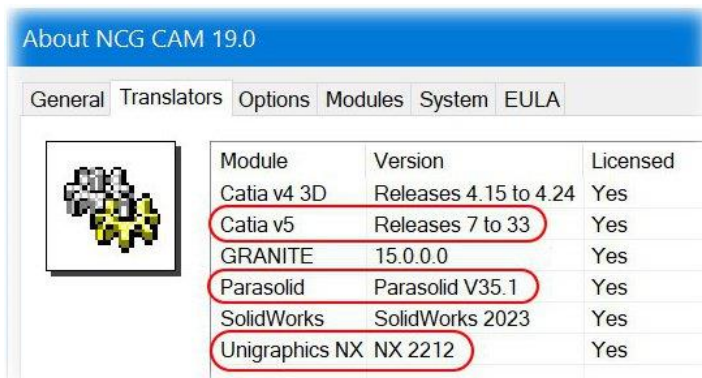

8870: Coordinate Systems: Creating a coordinate system from a datum point was not handling the rotations correctly, this has been fixed.

8875: Linking: Fixed a problem which could cause gouging in helical passes when very small machining tolerances are used.

8879: User Interface: Fixed an incorrect draw state that could happen when re-running plans that are not drawn.

8896: Compound Cycles: We now retain modified plan / folder names when loading saved compound cycles

8898: Linking: Performance improvements have been made to address a slowdown caused by ticket 8817 (Profile ramping enhancements).



8902: Toolsheets: Dimensions on toolpath images now only measure the toolpath.

NCG CAM v19.0.02		Boundary Toolpath 1 [20x3.5, 0]		12 May 2023	
<b>Cutter diameter</b>	<b>20</b>	<b>Corner radius</b>	<b>3.5</b>		
Tool name	Toroidal(20x3.5 40, 0)				
Cutter name	Toroidal(20x3.5 40, 0)				
Tool holder name	Not available				
Tool type	Toroidal				
Tool number	1				
Strategy	Boundary				
Body length	40				
Taper angle	0				
Thickness	0				
Tolerance	0.02				
Z clearance	55				
Step over	0				
Step down	0				
Spindle	2387				
Coolant	Off				
Rapid	10000				
Ramp down	895				
Cutting	1193				
Ramp up	1193				
<b>Shaft profile</b>					
Required body length	Not available				
Required cylindrical length	Not available				
<b>Home Point</b>					
	<b>X</b>	<b>Y</b>	<b>Z</b>		
Start	-191.924	0	55		
End	-191.924	0	55		

8921: Import: Updated Granite to v16.0.0.0. This provides support for Creo 10.0 files.

About NCG CAM 19.0

General Translators Options Modules System EULA

Module	Version	Licensed
Catia v4 3D	Releases 4.15 to 4.24	Yes
Catia v5	Releases 7 to 33	Yes
GRANITE	16.0.0.0	Yes
Parasolid	Parasolid V35.1	Yes
SolidWorks	SolidWorks 2023	Yes
Unigraphics NX	NX 2212	Yes

8930: User Interface: Changed the layout of the four-view mode in graphics views to match the four-view toolsheet image layout for consistency.

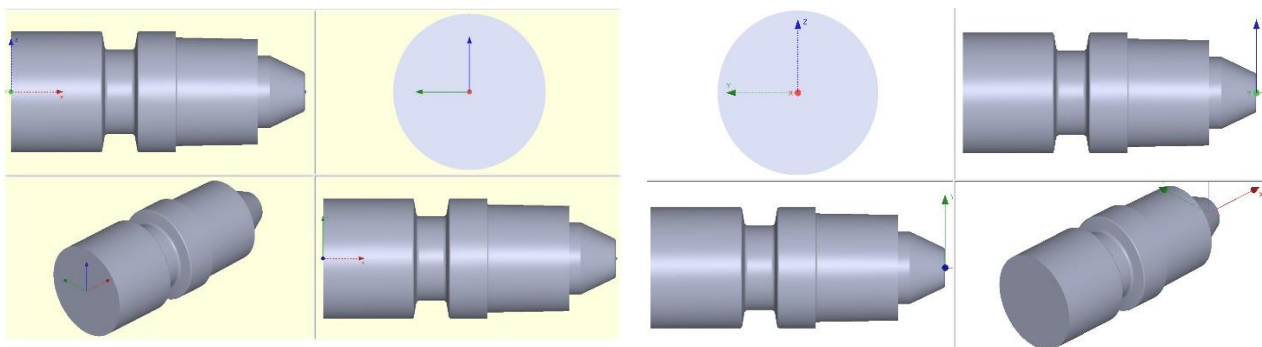

Four views in previous versions.

Four views in v10.0.02

8940: Cutter Simulation: There was a problem when unticking and ticking the simulated toolpath in the tree while the Cutter Simulation was paused could cause DEPOCAM to crash, this has now been fixed.

8953: User Interface: Fixed an issue with the view not updating when exiting the boundary editor.

8955: User Interface: Made the sizes of overlay elements (measuring rod, 3 point circle, direction arrows, nodes on the boundary, when in boundary edit mode) in graphics views consistent across different monitors.

8956: User Interface: The "Axes length in pixels" option has been removed from the axes options page, replaced by an option to set the length of axes in mm/inches as measured on the screen. An option has been added to scale the axes length with the view, which replaces the previous "Axes length in mm/inches" option.

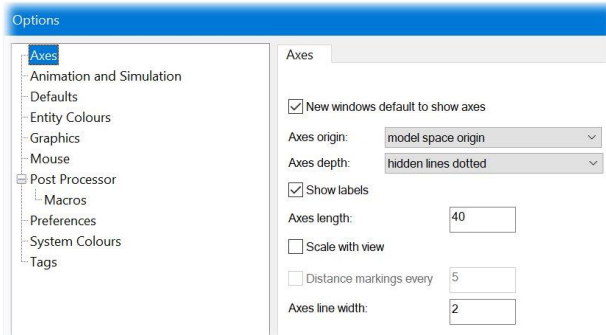

V19.0

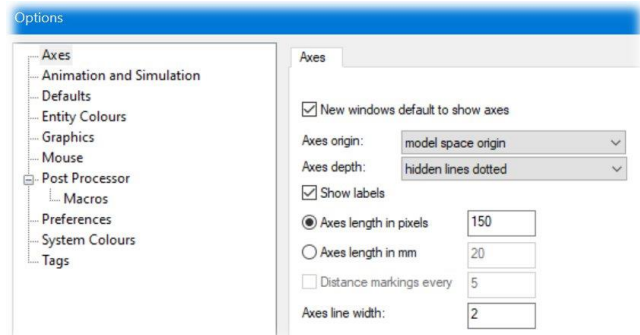

v18.0

Note, the 'Scale with view' option must be enabled if distance markings are required.

8957: User Interface: The bead radius in the cutter animation options is now set in mm/inches.

8958: User Interface: The keyboard translation distance in the graphics options is now measured in mm/inches on the screen when set to "screen space", rather than pixels.

8963: User Interface: The selection of a point/datum when creating a revolved surface is now optional, it will default to (0.0, 0.0, 0.0) for the position.

8986: User Interface: Improved smoothness of spheres in graphics views.

SOLIDWORKS is a trademark of Dassault Systems.

Catia is a trademark of Dassault Systems.

Parasolid is a trademark of Siemens

GPost is a trademark of Austin NC.

UG / NX is a trademark of Siemens

Datakit is a trademark of Datakit.

Granite, Pro/E, Creo are trademarks of Parametric Technologies Corporation.

Windows 10 and Windows 11 are trademarks of Microsoft.